



FORECOURTS



CRITICAL POWER SUPPLY



TRANSPORT REFUELLING



DATA CENTRES



Durapipe

PLX

Safe Pipework for Fuel

Technical Data & Dimensions

PIPEWORK FOR FUEL

Durapipe PLX is a complete range of dedicated fusion-welded pipework systems for the safe transfer of liquid fuels and their vapours. Suitable for use with leaded, unleaded petroleum, including ethanol rich alternative fuels (E85), diesel, bio-diesel and fuel oils.

PLX is commonly used in forecourts and is also used for critical power applications for hospitals, data centres, prisons and banks.

The Durapipe PLX range was originally developed over 20-years ago and through continuous product innovation, PLX plastic piping offers the ultimate in environmental protection with maximum protection against permeation and leak free joints when transferring fuel.

Durapipe PLX is fully compliant with the Energy Institute (Institute of Petroleum Performance systems), rigorous EN testing and other worldwide recognised standards.



We also offer PLX Blue – a pipe system purpose designed to convey AdBlue®/DEF.

With the ever-increasing use of AdBlue®/DEF to lower NOx concentrations in the exhaust emissions of diesel engines, a high quality pipework system is required to convey the solution from tank to pump. PLX Blue offers the choice of both single wall and dual contained, giving the option to be monitored for leak detection if required and offering peace of mind to the installer and client alike.



Key Product Information

- 10 bar pressure rating
- Temperature Rating: -20°C to 50°C
- Secondary containment system
- 30 year design life
- Size Range: 32mm to 315mm
- Electrofusion system

Typical Applications

- Critical/emergency power supply
- Oil-fired equipment
- Commercial and public transport refuelling

Key Product Features

- Suitable for pressure and vacuum applications
- Resists fuel permeation
- Corrosion resistant
- Protects the environment
- Easy to install



Contents

Introduction	4-17	Double Spigot Secondary Contained 90° Elbow	52
What is Durapipe PLX?	4-11	Secondary Contained Equal Tee	53
Sustainability		Secondary Contained Double Spigot Equal Spigot Tee	53
Added Value		Secondary Contained Reduced Branch Spigot Tee	53
Materials		Secondary Contained Interstitial Access Saddle	54
Manufacturing Process		Secondary Contained Interstitial Access Saddle 1/8" Access Port	54
Flow Nomogram		Pipe-in-Pipe Transitions	54-55
Durapipe PLX Electrofusion and Spigot Fittings	12-14	Secondary Contained Double Spigot Female BSP Transition	54
Durapipe PLX Product Innovations	16-17	Secondary Contained PE Stub Flange Assembly Transition	55
Technical	18-37	Secondary Contained Double Spigot Zoning In-Line Anchor	55
Installation Guide	18-20	Secondary Contained Double Spigot Support In-Line Anchor	55
Pressure Testing of PLX Product Lines Single Wall and Secondary Containment	21	PLX Blue Product Tables	56-61
Electrofusion Jointing / Installation inside a building	22	PLX Blue Pipe	56-57
Pipe Preparation Instructions	23-28	PLX Blue Single Wall Pipe SDR11 Straights	56
Single Wall – Primary Pipe Preparation		PLX Blue Close-Fit Pipe SDR11#26 Straights	57
Close-Fit – Pipe Preparation		PLX Blue Single Wall Fittings	57-58
Pipe-In-Pipe – Pipe Preparation		PLX Blue Single Wall Coupler	57
Single Wall Jointing Guide	29-30	PLX Blue Single Wall 45° Elbow	57
Secondary Containment Fittings	31	PLX Blue Single Wall 90° Elbow	57
Close-Fit Secondary Containment Jointing Guide	32-34	PLX Blue Single Wall Equal Tee (Spigot Branch)	58
Pipe-In-Pipe Secondary Containment Jointing Guide	35-37	PLX Blue Close-Fit Fittings	58-59
Single Wall Product Tables	38-43	Close-Fit Pipe Joiner	58
Single Wall Pipe	38-39	PLX Blue Close-Fit 45° Elbow	58
Single Wall Pipe SDR11 Straights	38	PLX Blue Close-Fit 90° Elbow	59
Single Wall Pipe SDR11 Coils	39	PLX Blue Close-Fit Equal Tee	59
Single Wall Gravity Fill & Vent Pipe SDR17	39	PLX Blue Close-Fit Slip Closure	59
Single Wall Fittings	39-41	PLX Blue Transitions	60-61
Single Wall Coupler	39	PLX Blue Single Wall EF Female BSP	60
Single Wall 45° Elbow	39	PLX Blue Close-Fit Slip Closure	60
Single Wall 90° Elbow	40	PLX Blue Close-Fit Slip Closure with Test Port	61
Single Wall Equal Tee (Spigot Branch)	40	PLX+	62-79
Single Wall Equal 3-Way EF Tee	40	Safe conductive pipework for Fuel	62
Single Wall Reducer	40	Installation Guide	63
Single Wall Spigot End Caps	41	Pipe Supports	64
Single Wall Transitions	41-43	Pressure Testing of PLX+ Product Lines Single Wall and Secondary Containment	65
Single Wall EF Female BSP	41	Durapipe PLX+ Electrofusion and Spigot Fittings	66
Single Wall EF Female Compact Flange BSP	41	Static Electricity	68
Single Wall Spigot Female BSP	41	Pipe Preparation Instructions	69
Single Wall Spigot Male BSP	42	All Single Wall – Primary Pipe Preparation	69
Single Wall Spigot Female Compact Flange BSP	42	Close-Fit – Pipe Preparation	71
Single Wall Long Spigot Female Extended BSP	42	Single Wall Jointing Guide	73
Single Wall Long Spigot Female Extended BSP Fill & Vent	42	Secondary Containment Fittings	75
Single Wall Long Spigot Female Compact Flange Extended BSP	43	Close-Fit Secondary Containment Jointing Guide	76
Single Wall Stub Flange (Zinc plated mild steel backing ring)	43	PLX+ Pipework Systems Product Tables	80-90
Single Wall SDR11 PE Stub Flange Assembly		PLX+ Pipe	80-81
(Galvanised Mild Steel backing ring)	43	Single Wall Pipe SDR11 Straights	80
Single Wall SDR17 PE Stub Flange Assembly		Single Wall Pipe SDR11 Coils	81
(Galvanised Mild Steel backing ring)	43	Single Wall Gravity Fill & Vent Pipe SDR17	81
Close-Fit Product Tables	44-49	Close-Fit Pipe SDR11#26 Straights	81
Close-Fit Pipe	44-45	Close-Fit Pipe SDR11#26 Coils	81
Close-Fit Pipe SDR11#26 Straights	44	Close-Fit Gravity Fill & Vent Pipe SDR17#26 Straights	81
Close-Fit Pipe SDR11#26 Coils	45	PLX+ Single Wall Fittings	82
Close-Fit Fill & Vent Pipe SDR17#26 Straights	45	Single Wall Coupler	82
Close-Fit Fittings	45-47	Single Wall 45° Elbow	82
Close-Fit Joiner	45	Single Wall 90° Elbow	82
Secondary Contained 45° Elbow	46	Single Wall Equal Tee	82
Secondary Contained 90° Elbow	46	PLX+ Secondary Contained Transitions	83-84
Close-Fit Hockey Stick SDR11#26	46	Close-Fit Pipe Joiner	83
Secondary Contained Equal Tee	47	Secondary Contained 45° Elbow	83
Secondary Contained Slip Closure	47	Secondary Contained 90° Elbow	83
Secondary Contained Slip Closure with 1/8" BSP Access Port	47	Secondary Contained Tee	83
Secondary Contained Slip Closure with 1/8" BSP Access Port	47	Secondary Contained Slip Closure	84
Close-Fit Transitions	48	Secondary Contained Slip Closure with 1/8" BSP Access Port	84
Close-Fit Reducer	48	PLX+ Single Wall Transitions	84-85
Close-Fit EF Female BSP	48	Single Wall Long Spigot Female Extended BSP	84
Close-Fit EF Female BSP with Test Port	48	Single Wall Long Spigot Female Extended BSP Fill & Vent	85
Single Wall EF Female Compact Flange BSP	48	Single Wall Long Spigot Female Compact Flange Extended BSP	85
Single Wall Spigot Female Compact Flange BSP	49	Single Wall Stub Flange	85
Single Wall Spigot Female Extended BSP Fill & Vent	49	Single Wall PE Stub Flange Assembly	85
Single Wall SDR11 Stub Flange	49	PLX+ Secondary Contained Transitions	86-87
Single Wall PE Stub Flange Assembly - SDR11	49	Close-Fit EF Female BSP	86
Pipe-in-Pipe Product Tables	50-55	Close-Fit EF Female BSP with Test Port	86
Pipe-in-Pipe	50-54	Single Wall Spigot Female Extended BSP Fill & Vent	86
Pipe-in-Pipe Straights	50	Single Wall SDR11 Stub Flange	87
Secondary Contained Primary Coupler with Leads	51	Single Wall SDR17 Stub Flange Fill & Vent	87
Pipe-in-Pipe Secondary Slip Coupler	51	PLX Accessories	88-91
Pipe-in-Pipe Reducer	51	Accessory Fittings	88
Secondary Contained 45° Elbow	51	Welding Machines & Accessories	89
Double Spigot Secondary Contained 45° Elbow	52	Preparation Tools	90
Secondary Contained 90° Elbow	52	General Information	92-94

What is Durapipe PLX?

Durapipe PLX is a high performance multi-layered polyethylene composite pipe system, supplied in single wall and secondary containment product ranges for various fuelling applications in retail, commercial and industrial markets. Fusion welded for the greatest joint integrity, PLX is a specialist range of pipe and fittings specifically designed for the safe transfer of fuel-based liquids and their vapour in pumped or vacuum applications.

Within Durapipe PLX are the following sub-ranges:

Single Wall

32mm up to 315mm, for below ground applications and available in straight lengths and coils.



See page 38

Close-Fit

32#40mm up to 110#125mm, compact secondary containment system for specific above and below ground applications. Available in straight lengths and coils.



See page 44

Pipe-In-Pipe

32#63mm up to 160#225mm secondary containment system for specific above and below ground applications. Available in straight lengths. Up to 315#450mm available on request.



See page 50

PLX Blue

32mm up to 63#75mm single wall and secondary containment system specifically tested for AdBlue/DEF. Available in straight lengths.



See page 56

PLX+

63mm up to 110#125mm 'conductive' single wall and secondary containment system, available in straight lengths and coils.



See page 62

PLX offers tremendous advantages over traditional materials:

- Single Wall and Secondary Contained systems available
- Safe and Durable (30 year design life)
- High Performance 10bar primary pipes
- Corrosion Resistant
- Maintenance Free
- Resists permeation quick, clean and easy Electrofusion Jointing and Installation
- Dedicated range of matched fittings
- Dimensional stability
- Strong and robust
- UV Resistant
- Full range of accessories and jointing tools
- Allows for interstitial monitoring and environmental protection

Pressure and Flow Ratings

PLX primary pipework has a maximum pressure rating of 10bar at 20°C for SDR11 and 4bar at 20°C for SDR17 pipework. Durapipe PLX Secondary pipework has a maximum pressure rating of 4bar at 20°C. Please note that when a fitting is 10bar rated and used in conjunction with a SDR17 4bar pipe, then this will result in a 4bar system.

The smooth protective barrier layer of PLX offers a negligible resistance to flow and will not corrode or support microbial growth or deteriorate with use. PLX will maximise flow rates with greater pump efficiency and minimal operating cost.

PLX Fill & Vent (SDR17) improves the filling times of Underground Storage Tanks (USTs) and lessens the chance of tank pressurisation and over filling.

The graph below shows the reduction factor, which should be applied to the recommended maximum continuous working pressure at 20°C to obtain appropriate working pressures for elevated temperatures.

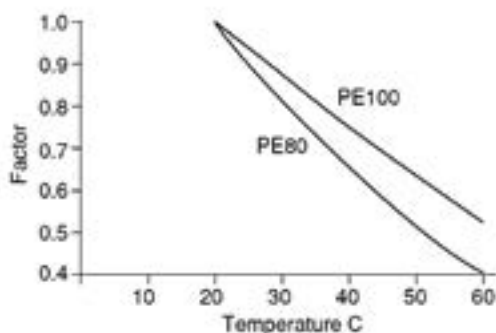

Reduction factor vs Temperature Graph

The reduction graph has been calculated to give normal factors of safety after 50 years. It refers only to the conveyance of fluids to which the pipe material is completely resistant.

At temperatures lower than 20°C, polyethylene becomes stiffer and stronger, with strength increasing by 1.3% per °C reduction.

Secondary Containment

Fuel industry guidelines are making it mandatory that pressurised (including gravity head) below ground fuel lines are secondary contained or installed in a banded area.

PLX secondary contained Close-Fit and Pipe-In-Pipe systems provide security against accidental fuel losses whilst providing an opportunity for continuous interstitial monitoring and environmental protection, through leak detection, in both below ground and above ground applications.

PLX Fittings Range

The PLX system comprises of a wide range of Single Wall and Secondary Contained Electrofusion (EF), Spigot and combined EF#Spigot fittings in couplers, elbows, tees and closures. The jointing of PLX systems by means of electrofusion offers a permanent, rapid and convenient method of creating leak-free joints. *For full jointing instructions please go to page 30.*

PLX electrofusion fittings are designed to work on a fixed fusion time for environmental temperatures between -5°C and +23°C. All PLX ECU's include built-in temperature compensation sensors which adapt accordingly to the ambient temperature. Fusion cycle temperature compensation times must be applied at temperatures below -5°C and above 23°C. When using a manual input Electrofusion Control Unit (ECU), the variant compensation time needs to be added/subtracted appropriately.

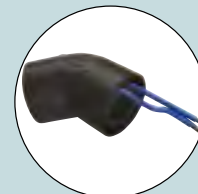

Transition Fittings

Reliable connections to steel components is vital in most plastic pipe systems and none more so than in fuel applications. PLX transitions combine the benefits of steel and plastics to ensure their design is resistant to end load and bending forces.

Available in either spigot or electrofusion format, PLX transition fittings have been innovatively designed to suit their intended application and provide ease of installation. Manufactured using the highest-grade materials, transition fittings are available in single wall and secondary contained format.



Chemical Resistance

Durapipe PLX has a highly visible bore that ensures negligible permeation, low absorption and dimensional stability, whilst providing excellent chemical resistance to the Volatile Organic Compounds (VOCs) of fuels including petrol, diesels, fuel oils and biofuels.

PLX Blue is suitable for the distribution of DEF (Diesel Exhaust Fluid) systems such as AdBlue®.

Petrol and diesel fuels are produced in oil refineries using a distillation process. The virgin fuels separated from crude oil during this process do not, on their own, meet the required specifications for combustion or emissions for modern engines (in particular octane rating) and so are blended with a series of other hydrocarbons Volatile Organic Compounds (VOCs) and performance additives to create the required properties.

With ever increasing global demands on finite fossil fuel deposits the global market is looking for substitutes in the form of biofuels produced from a variety of feed stocks and used as a complete substitute or blended. The highly visible bonded lining and composite pipe structure ensures negligible permeation, low absorption and dimensional stability.



PLX has a high resistance to the following liquid fuels and their vapour:

- Petrol
- Diesel
- Rapeseed oil
- Kerosene
- E10 (petrol with 10% ethanol)
- E20 (Gasoline with 20% ethanol)
- E85 (Gasoline with 85% ethanol)
- E100 (Pure ethanol)
- B5 (Diesel with up to 5% biodiesel)
- B20 (Diesel with up to 20% biodiesel)
- B100 (Pure biodiesel)
- AdBlue/DEF (PLX Blue only)



Corrosion Resistance

Being corrosion resistant, the bonded composite structure of PLX combines the properties of polyethylene and the protective barrier layer.

Both are renowned for their resistance to chemical attack, and in service will not rot, rust, pit or corrode, nor will it support microbial growth. Either buried or above ground, PLX systems are maintenance free. The pipe's smooth lined bore offers low friction and minimum resistance to flow. Corrosion resistant transition fittings are available in zinc plated mild steel, stainless steel, or polyethylene stub flanges.



UV Resistance

Pigmented with carbon black, PLX secondary contained Close-Fit and Pipe-In-Pipe systems have excellent resistance to UV light.

Even under the most severe conditions the secondary pipe will retain most of its mechanical and physical properties and will wholly protect the primary pipe. The pressure rating and 30 year design life is unaffected by exposure to sunlight.

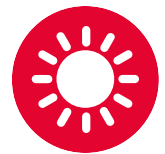

Abuse Resistance

PLX has ductile characteristics and has exceptional resistance to abrasion, mechanical and physical abuse. Its strength and ductility will accommodate occasional pressure surges of up to twice the pipe's pressure rating.



Abrasion Resistance

Polyethylene has excellent abrasion resistance. During installation, the abrasive particles of typical soils and backfills do not reduce the design life or pressure rating of the system.



Note: In the unlikely event of a notch or groove being cut into the external surface by more than 10 per cent of the wall thickness, the pipe section should be rejected.

Insulation/Trace Heating

With the ever-increasing use of bio-diesel, it is important to protect pipe contents from waxing at low temperatures. This is especially important in fuel systems that may be quiescent for long periods, e.g. generators for critical power systems.



Depending on the bio-diesel feedstock oil, waxing can begin to occur between temperatures of +16°C and -10°C. Polyethylene is a good insulator and the PLX Pipe-In-Pipe system can provide short term protection.

In exposed fuel systems conveying bio-diesel, the PLX Pipe-In-Pipe system should be considered in conjunction with a fuel recirculation system. We recommend that trace heating is applied to the outside of the secondary pipe and insulated accordingly.

Low Installed Life Costs

The ease of handling and speed of jointing of PLX will generally result in the total installed cost being lower than it is for threaded or welded metal systems.



Pipework installation can be completed in significantly less time than for metal systems. As the installation of PLX is not classed as 'hot works' it can be safely undertaken in most environments.

Quality, Dimensions and Standards

Durapipe UK's commitment to quality is reflected by our operation of an independently assessed quality management system registered under BS EN ISO 9001.

PLX products are made in accordance with the following Standards:

Pipe

EN14125, DIN 8074, 8075, OFTEC, EI, UL971v1, IPv1

Fittings

EN14125, BS EN 1555, OFTEC, AREL (Transitions), EI, UL971v1

Threaded transition fittings conform to the nominal requirements of BS 21/DIN 2999/ISO 7 specifications. Male and Female threads are tapered. Flanged drillings conform to the nominal requirements of BS4504, DIN2501 Table 10 and Table 16.



Sustainability

Introduction

Plastic piping systems are a sustainable and environmentally responsible choice that will serve generations to come. They are energy efficient during manufacturing and provide peak performance during service. Strong, durable, lightweight and flexible, plastic piping systems require significantly less energy to manufacture, transport and install than metal alternatives, and supply a long service life.



The cumulative energy requirements to manufacture, install and transport plastic pipework is estimated to be substantially less than most non-plastic systems. Plastic saves energy – besides the technical advantages of plastics (e.g. Corrosion resistance) there are inherent benefits that contribute to energy efficiency and energy sustainability. The chain of activity outlined on the opposite page highlights where plastic has a positive impact compared to copper and steel which have a higher energy demand.

Durapipe & Aliaxis

The continuous mission of Durapipe and the Aliaxis group is to ensure our product offering is as sustainable as possible and considers the impacts on the environment, whilst maintaining the highest quality and performance.

- Comply with all relevant environmental legislation, codes of practice and standards relating to quality and the environment.
- Continually improve the company's environmental performance, minimising any pollution risk and adopting best practice.
- Increase usage of recycled materials where appropriate.
- Take positive action to reduce waste by promoting energy conservation and recycling.
- Optimising production processes.
- Consolidating transportation routes across group companies.

Durapipe Environmental Management System

Durapipe UK operates an environmental management system that has been successfully assessed against the BS EN ISO 14001 environmental management system.



Added Value

Technical Support

We offer an unrivalled level of technical support where our experienced team can provide product training and installation advice on any given project. They also provide material estimate advice from architects' drawings.



Company Chemist

Our internal company chemist is at your disposal. If you have concerns regarding the chemical combination that a pipework system needs to convey, we can evaluate suitability of the chemical you wish to convey and advise on the best available Durapipe material to use for the system.



Global Distribution Network

All of our products are available from an extensive network of distributors and stockists. Please contact us on +44 (0)844 800 5509 for details of your nearest outlet.



Quality Manufacturing

As part of the global Aliaxis group, quality is central to our manufacturing operation with BS EN ISO9001 certification. Furthermore, an environmental management system which operates in accordance with the requirements of ISO 14001.



Customer Service

We pride ourselves on being able to offer the highest level of customer service possible. Our customer services support team cover all of our brands as well as stock planning and availability, all designed to provide you, our customer with an improved level of service.



Installation Advice

One of the many benefits of using plastic pipework systems instead of traditional materials is the simplicity of the jointing process. We offer FREE practical product selection & jointing advice on our PLX range including jointing demonstrations, installation advice and even material selection.



Materials

Durapipe PLX pipe and fittings range is a polyethylene based system with PLX pipe having additional features and benefits of a bonded composite structure. PLX has a protective barrier layer, offering a smooth bore that ensures negligible permeation.



Polyethylene

All products are made from virgin polyethylene. Polyethylene is a thermoplastic belonging to the material group of polyolefins. Polyethylene offers numerous features and benefits over traditional materials that include:

Features

- Mechanical strength
- Chemical resistance
- Carbon black properties
- Electrofusion jointing

Benefits

- Does not support microbial growth
- Minimises frictional head losses
- Continuous flow rate
- Resists permeation of VOCs

Protective Barrier Layer

All primary pipes are co-extruded and have a lined bore surface. The protective barrier layer has similar mechanical and physical properties to polyethylene. Bonding these materials together offers numerous benefits over unlined pipe:

Features

- Smooth bore
- Clearly visible bore layer
- Chemical resistance

Benefits

- Does not support microbial growth
- Minimises frictional head losses
- Continuous flow rate
- Resists permeation of VOCs



Property	Method of Test	Units	PE80 (MDPE)	PE10 (HDPE)
Melt flow rate -				
2.16kg load	BS2782 ISO 1133	g/10min	0.2	<0.15
5kg load	BS2782 ISO 1133	g/10min	1.0	<0.5
Density (Mean Values)	BS3412 ISO 1872	kg/m ³	950	957
Tensile strength at yield	BS2782	MPa	18	23
Elongation at break	BS2782 ISO R527	%	>600	>600
Flexural Modulus	BS2782 ISO R527	MPa	700	1000
Vicat softening point	BS2782	°C	116	124
Brittleness temperature	ASTM D746 ISO 9784	°C	<-70	<-100
Linear thermal expansion	ASTM D696	°C	1.5 x 10 ⁻⁴	1.3 x 10 ⁻⁴
Thermal conductivity	BS874 DIN 52612	W/m ² K	0.4	0.4

Further details may be obtained from Durapipe Technical Support Department.

These values are typical. The actual value depends on exact material, pipe sizes, etc.

Standard Dimensional Ratio (SDR)

One of the items of information contained on both pipe and fittings is the Standard Dimensional Ratio, i.e. the ratio between wall thickness and outside diameter.

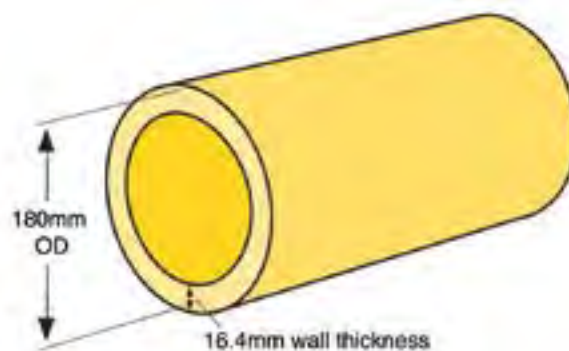

Manufacturing Process

Durapipe PLX pipe is a composite material manufactured by a state of the art co-extrusion process. The pipe consists of an outer pressure bearing layer of polyethylene material, and an inner bore layer which provides the fuel barrier. All of the raw materials used for PLX production are virgin polymers and subjected to rigorous quality control tests.

Finished pipe is subjected to quality control tests dictated by the product specification and industry standard, these include mechanical properties, thermal stability, pressure resistance, low temperature impact resistance and inter-layer bond strength.



Flow Nomogram

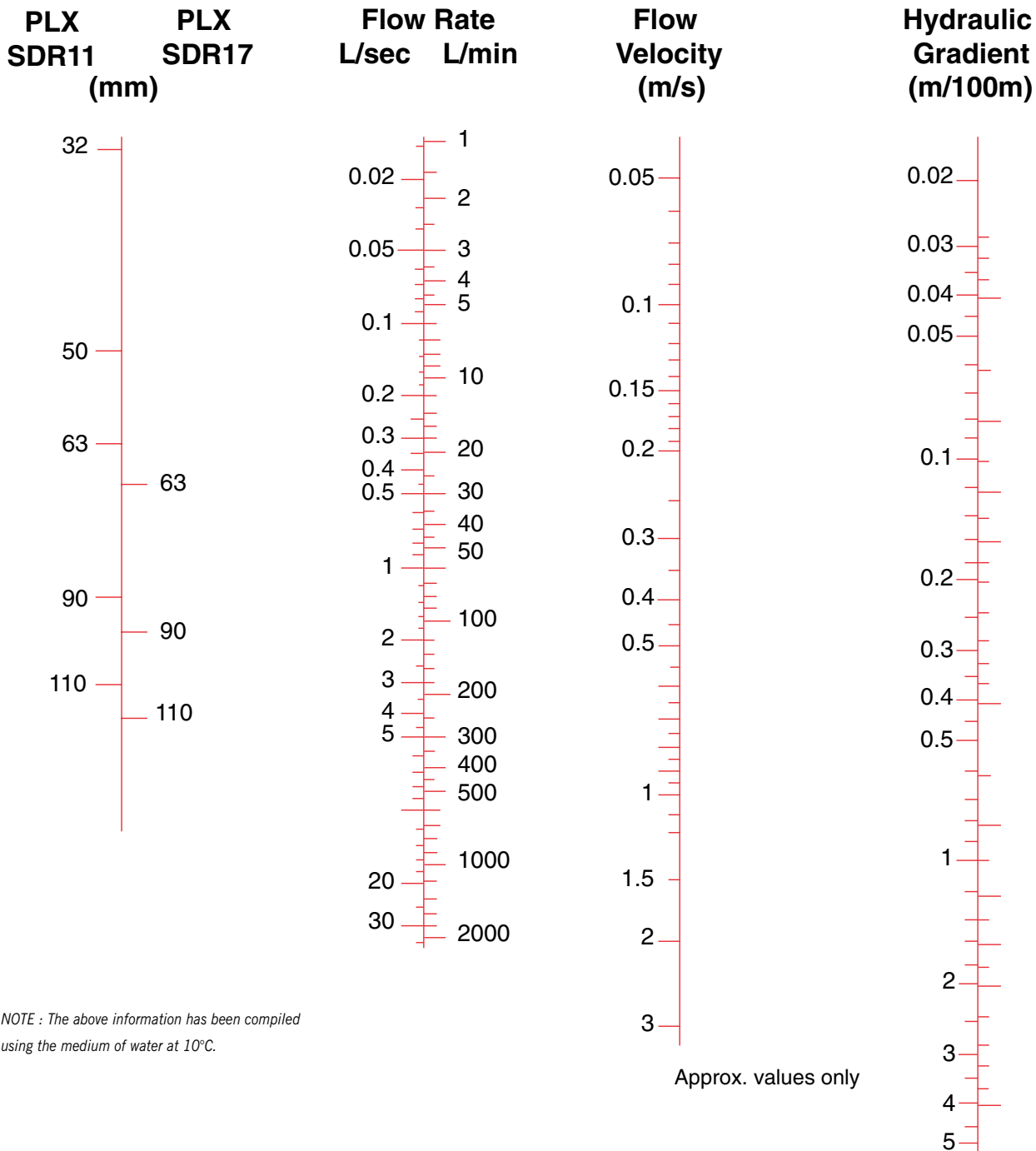

NOTE : The above information has been compiled using the medium of water at 10°C.

Flow calculations

Pressure drop due to friction in pipes conveying water can be determined using the Flow Nomogram on page 13. The pressure drop at a given flow rate can be determined as follows:

1. Obtain the internal diameter of the pipe to be used.
2. Mark this diameter on Scale A.
3. Mark the required flow rate in litres per second on Scale B.
4. Draw a straight line connecting the points on Scales A and B and extend this to Scales C and D.
5. The velocity of flow in metres per second is determined from the intersection with Scale C.
6. The frictional head loss in metres per 100 metres of pipe can then be read off Scale D.

Durapipe PLX Electrofusion and Spigot Fittings

The PLX system comprises of a wide range of Single Wall and Secondary Contained Spigot and Electrofusion fittings - couplers, elbows, tees and closures. The jointing of PLX pipes through electrofusion offers a permanent, rapid and convenient method of pipe joining.

This advanced innovative manufacturing technique of all fittings ensures:

- Deep electrofusion sockets for maximum joint strength on primary pipes
- Gap filling fusion joint process
- 39.5V Operation
- The heating coils are placed as close to the joint surfaces as possible
- Wire position accurately controlled during manufacture and the fusion process
- Uniform heat distribution during the electrofusion process
- Melt pressure and temperature are both accurately controlled
- Heating coils are protected from damage during installation
- Barcoded containing size and fusion and cooling times
- Fusion indicators
- Mushroom caps - used after the cooling process for insulating the fusion terminals

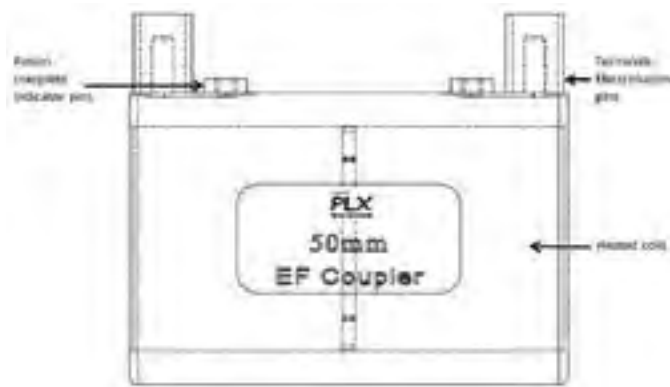

All PLX electrofusion fittings employ the same basic principle. The socket of the fitting incorporates an electrical heating coil. An electrofusion control unit (ECU) regulates and supplies the power necessary to energise and heat the coil. When the coil is energised the immediate pipe and fitting surfaces melt to form an expanding pressurised pool of molten material. The continued introduction of heat energy causes the expanding pool of molten material to mix under the melt pressure, forming a homogenous mass that is vital in producing a good weld. Following the termination of the heat cycle, the fitting and pipe are left to cool allowing the melted material to solidify to form a joint that is stronger than the pipe.

Using PLX EF fittings, consistent, reproducible, high integrity joints will be achieved if:

- Pipe and fittings preparation instructions are followed (see page 23)
- Pipe and fittings assembly instructions are followed (see page 29)

This will ensure that the installed PLX systems are wholly secure with leak tight joints.

Electrofusion Principles

Hot and cold zones, sometimes called melt and freeze zones, are formed after energising the coil. The cold zones ensure that molten material is locked in place and that a melt pressure is created and controlled throughout the jointing process. The precisely controlled pitch and positioning of the heating coil in relation to the inner surface of the socket ensures uniform heat distribution.

PLX electrofusion fittings are designed for use with 39.5 volt output Electrofusion Control Units.

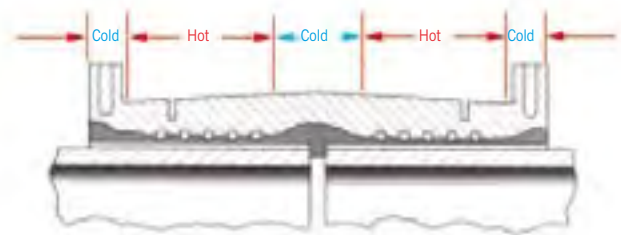

The Fusion sequence

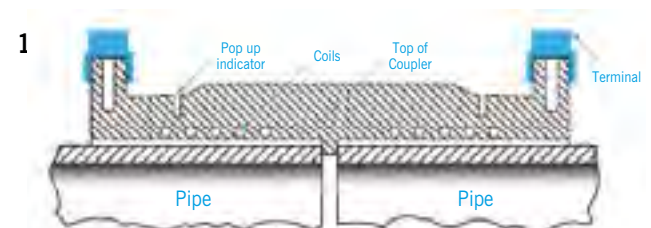

Pipe positioned in coupler prior to energising coil.

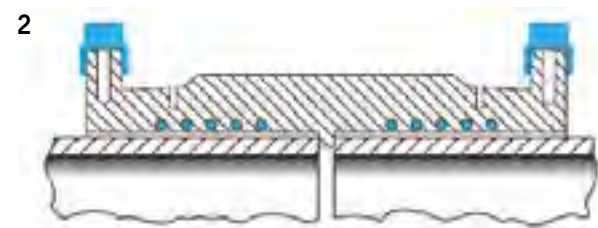

Coil energised.

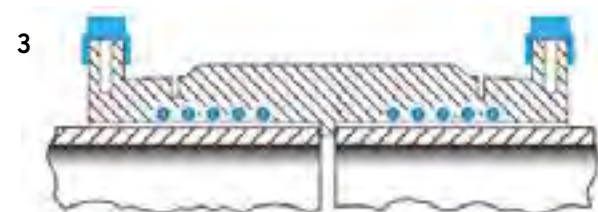

Material surrounding coils starts to melt.

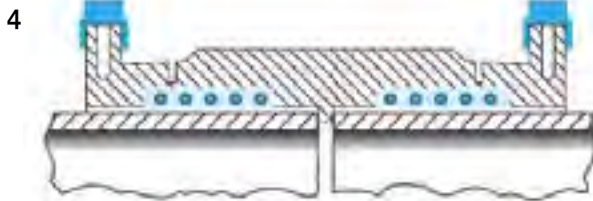

Area of melt extends leading to expansion towards pipe surface.

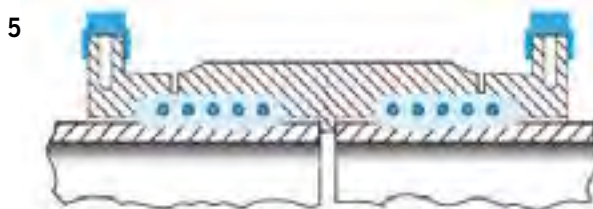

Heat transfers to pipe wall and pipe material starts to melt.

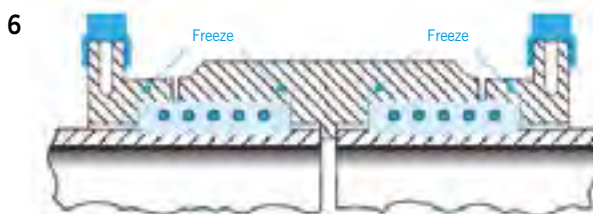

Melt solidifies at the start of the cold zones, thereby sealing the melt zone. Further input of energy causes increase in melt pressure.

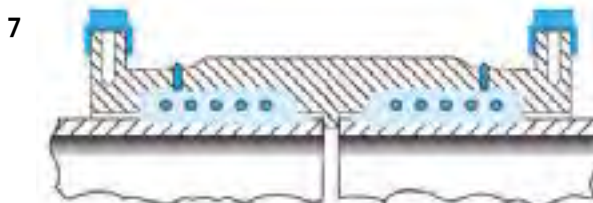

Melt pressure reaches optimum value at end of energising cycle. Emergence of the melt at the indicator holes shows that fusion is complete.

The height of the weld indicators, post-weld is not directly related to the quality of the joint formed.

IT IS IMPERATIVE THAT MUSHROOM CAPS ARE FITTED ONTO BOTH TERMINALS AFTER WELDING PROCESS HAS BEEN COMPLETED.

PLX Barcode Introduction

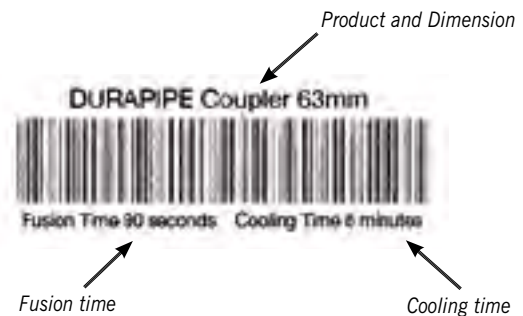

Technology is now available which eliminates the need to enter the fusion time manually. Electrofusion control units (ECUs) can be supplied with the ability to read a barcode where fixed to an electrofusion fitting. These machines have a 'light pen' attached, which the operator uses to input the data by scanning the barcode. Barcode or automatic control units also have data logging facilities that provide traceability of site welding parameters. An output socket on the ECU allows downloading of this information onto a computer database or printer to give a complete Quality Check (QC) record of the joints which have been made. This information can be downloaded daily, or upon completion of the project. The units will store up to 200 operations. The ECU barcode will display a description of the fitting, which includes three digits to denote size, and this should be read and checked by the operator before proceeding.

Temperature/Fusion Time Compensation

Durapipe PLX electrofusion fittings are designed to work on a fixed fusion time in ambient temperatures between -5°C and +23°C. For further details on fusion time compensation please contact Durapipe Technical Support.



TEMPERATURE COMPENSATION										
Temp (°C)	10	15	20	25	30	35	40	45	50	55
10	90	90	90	90	90	90	90	90	90	90
15	90	90	90	90	90	90	90	90	90	90
20	90	90	90	90	90	90	90	90	90	90
25	90	90	90	90	90	90	90	90	90	90
30	90	90	90	90	90	90	90	90	90	90
35	90	90	90	90	90	90	90	90	90	90
40	90	90	90	90	90	90	90	90	90	90
45	90	90	90	90	90	90	90	90	90	90
50	90	90	90	90	90	90	90	90	90	90
55	90	90	90	90	90	90	90	90	90	90

Temperature Compensation Chart

PLX Secondary Contained Electrofusion#Short Spigot (EF#SS) Fittings

Durapipe PLX Secondary Contained Fittings are designed to ensure that the primary and secondary pipe systems function independently. Each of the Secondary Contained Electrofusion fittings are supplied with a primary electrofusion fitting inside an outer spigot fitting allowing the primary pipe to be fusion welded independently of the secondary system. The standard terminal shrouds and pins of the primary pipe are replaced at the factory with extended wire leads which allow for the safe weld to take place. Once fusion is complete they serve no further purpose and can be removed. 'Spring loaded' Terminal adaptor pins (Code 43 EWO 004) are used to provide the connection between the EF fitting 'flying leads' and the ECU 4.7mm pin output leads.

The pipe and fitting interstice is fully sealed by fusing the secondary spigot fittings to the secondary pipes by using either slip closures or short pattern PLX Secondary electrofusion couplers.



PLX Transition Fittings

PLX Transition fittings ensure the safe continuous flow of fuel when connecting to and from pumps, tanks and other metal threaded and flanged connections. Transition fittings are manufactured using the highest quality materials. With the ease of installation and system integrity paramount, the fittings have been designed to save time and costs during the installation process.

Compact and easy to fit the deep sockets of the electrofusion transition fittings give greater control of the jointing cycle while the smooth bore of the extended Single Wall and Secondary Contained Spigot fittings ensures there is minimal affect on the flow of fuel through PLX connections. The design of the Secondary Containment extended spigot fittings ensures the complete system is secondary contained and the interstice can be pressure tested and monitored.



PLX Pipe End Closures and Interstitial Access Points

PLX Electrofusion pipe closures seal the secondary to the primary pipe and allow the interstice to be initially and periodically pressure tested and permanently monitored.

On remote or unattended installations leak detection systems can be installed to continuously monitor for accidental losses and system damage.

Environmental monitoring systems can be designed for use with either liquid detection, over-pressure or under-pressure operation and fitted with a variety of audible alarms and warning devices and safely linked to active fail safe valves or interface with the Building Management systems (BMS).

Multi-port manifolds are used to group and simultaneously monitor a number of fuel lines.

PLX Access tees and saddles have been designed with monitoring and leak detection in mind ensuring that the installation is as convenient as possible.

See page 17 for details on leak detection systems.



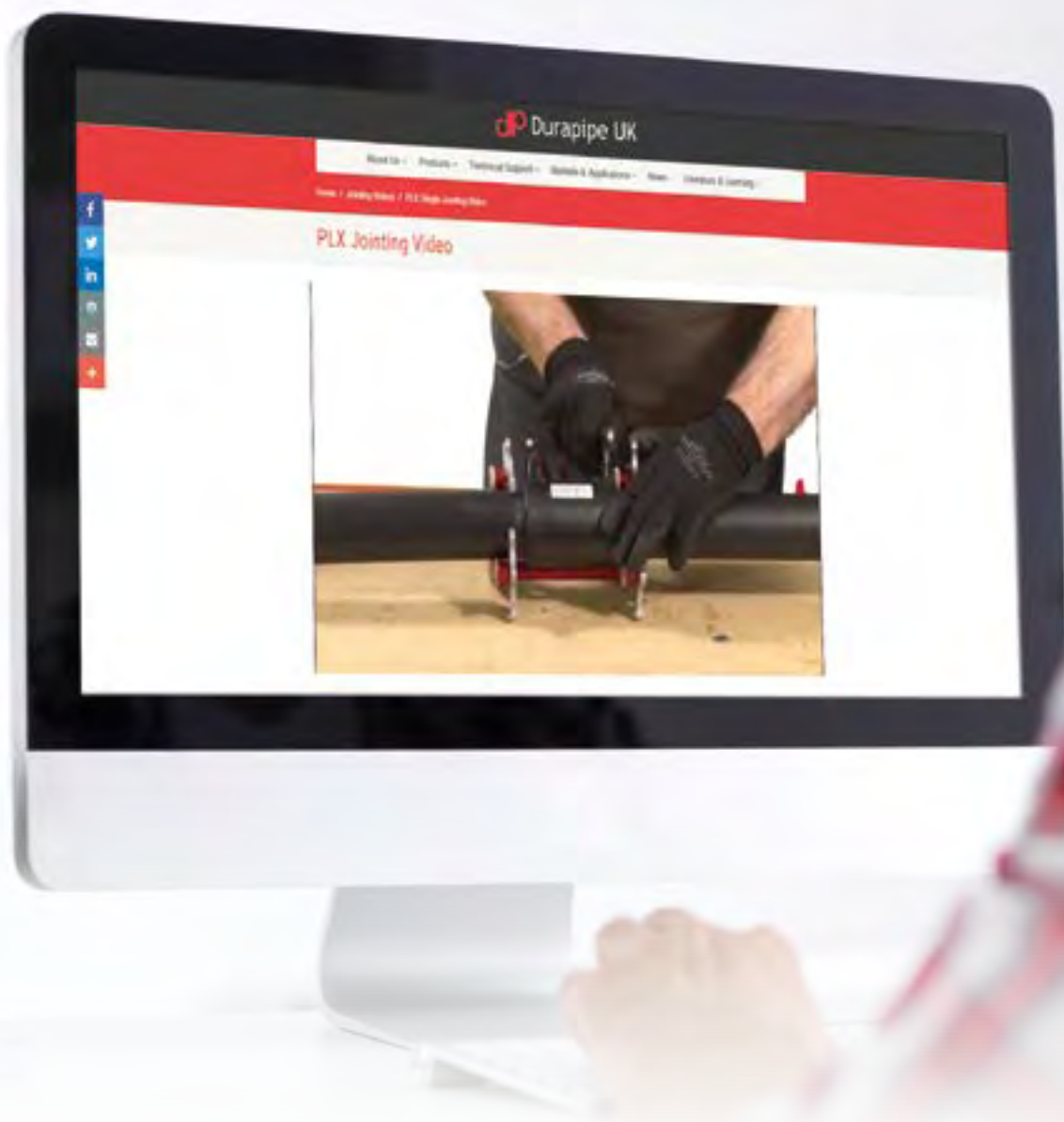

Jointing Advice from Durapipe

Watch our jointing video tutorials at:

www.durapipe.co.uk/technical-support/jointing-videos

Alternatively, our team can provide free practical product jointing advice on our range of pipework systems.

Durapipe PLX Product Innovations

Since its original in 1993, Durapipe PLX has developed many new products. This is particularly relevant in the last few years, where the range has evolved significantly. All of these products have been specifically designed and manufactured to the highest standards for fuel related installations and applications.

Here are some examples of the recent PLX innovations:

PLX+

Durapipe PLX+ is a 'conductive' fuel pipework system, with a complete range of dedicated fusion-welded pipework systems for the safe transfer of fuels. Suitable for use with diesel, bio-diesel and fuel oils. The Durapipe PLX+ range represents a major innovation in pipework technology as it offers the ultimate in environmental protection with maximum protection against permeation, and leak free joints.

The integral conductive connector ensures that there are no loose items which could go missing during the installation process, whilst the green and yellow striping gives clear indication that the pipe system is 'conductive'. Please see page 64 for further information.



Key Product Information

- 10 bar pressure rating
- Single wall and secondary containment systems
- 30 year design life
- Size Range: 63mm to 110#125mm
- Electrofusion system

Applications

- Suction Systems
- Offset Fill
- Vents
- Tank Chamber Connection
- Sump & Pump Connection

Key Product Features

- Integral conductive connector
- Green & yellow striping to indicate earthing
- Resists fuel permeation
- Corrosion resistant
- Protects the environment
- Easy to install

Products

- Single Wall
- Secondary Containment
- Threaded Transitions
- Flanged Transitions

PLX Blue

With the ever-increasing use of AdBlue®/DEF to lower NOx concentrations in the exhaust emissions of diesel engines, a high quality pipework system is required to convey the solution from tank to pump. PLX Blue offers the choice of both single wall and dual contained, giving the option to be monitored for leak detection if required and offering peace of mind to the installer and client alike.



Key Product Information

- 10 bar pressure rating
- Single wall and secondary containment systems
- 30 year design life
- Size Range: 32mm to 63#75mm
- Electrofusion system

Applications

- Suction Systems
- Offset Fill
- Vents
- Tank Chamber Connection
- Sump & Pump Connection

Key Product Features

- Sky blue striping to indicate AdBlue/DEF
- Specifically tested for application
- Corrosion resistant
- Protects the environment
- Easy to install

Products

- Single Wall
- Secondary Containment
- Stainless Steel Threaded Transitions

PLX Large Diameter Close-Fit

Consisting of sizes 90#110mm and 110#125mm, this range within PLX offers a more compact and streamlined pipe system for the filling and vent aspect of a typical forecourt installation.

The elbows are more compact and now have an electrofusion primary, which improves installation times and usability in tight spaces. This range supersedes the current Pipe-in-Pipe range (90#160mm and 110#160mm) for SDR17 Fill & Vent applications. For transitions, please see pages 56 and 57, which shows suitable transitions in both 90mm and 110mm.



Key Product Information

- 4 bar pressure rating primary (SDR17)
- 2 bar pressure rating secondary
- 30 year design life
- Size Range: 90#110mm and 110#125mm
- Electrofusion system

Applications

- Suction Systems
- Offset Fill
- Vents
- Tank Chamber Connection
- Sump & Pump Connection

Key Product Features

- Red stripe to indicate fuel
- SDR17 primary offers greater flow rates
- Resists fuel permeation
- Protects the environment
- Easy to install
- New fittings more compact

Products

- Secondary Containment
- Threaded Transitions
- Flanged Transitions

PLX 50#63mm and 63#75mm 'One-Weld' Transitions

These innovative transitions are a continuation of the current 32#40mm offering, which include the time saving 'One-Weld' technology.

This technology enables the installer to reduce the number of welds at the end of a pipe run, which reduces installation time and costs. This genuine innovation enhances the Durapipe PLX transition range even further.



Key Product Information

- 10 bar pressure rating primary
- 4 bar pressure rating secondary
- Size Range: 50#63mm and 63#75mm
- Female threaded BSP zinc plated steel connection
- Test port option
- 30 year design life

Applications

- Suction Systems
- Vents
- Tank Chamber Connection
- Sump & Pump Connection

Key Product Features

- Compact transition
- Leak detection and pressure test option
- Time saving during installation
- 3 fittings in one
- Easy to install

Products

- Close-Fit
- Secondary Containment
- Threaded Transitions
- Available in standard PLX and also PLX+

Leak Detection Systems for Durapipe PLX

There are many leak detection systems on the market which are compatible with Durapipe PLX. These systems monitor the interstitial space and detect low levels of moisture, which helps to protect the environment and give peace of mind.

Durapipe PLX offers specifically designed transitions, closures and saddles in order to easily connect to a leak detection system.

Please see below (non-exhaustive) list of recommended leak detection specialists, who will be happy to assist with your enquires:

Afriso Eurogauge
SGB
Andel*

Crawley, UK
Siegen, Germany
Huddersfield, UK

+44 (0)1293 658360
+49 (0)271/48964-0
+44 (0)1484 845 000

www.eurogauge.co.uk
www.sgb.de
www.andel.co.uk

*Pipe-in-Pipe system only

Installation Guide

Durapipe PLX products are designed to make the installation of fuel lines quicker, easier and more cost-effective than when using traditional materials. The advantages of installing with PLX systems are lightness flexibility, durability and totally secure jointing methods.

PLX System Presentations, Demonstrations and Technical Support

We offer an unrivalled level of technical support where our experienced team can provide product introductions, jointing demonstrations and installation advice on any given project. They can also provide material estimates for indicative costs from engineering drawings.

Personnel should be fully competent and conversant with the design and installation of PLX pipe systems.

On-site PLX pipe jointing demonstrations can be arranged on request.

Technical Support is available, before, during and after installation.



Trench Excavation

Where pipework has to be laid in trenches, PLX pipe systems require minimal excavation. Trench dimensions are normally governed by the pipe diameter and site conditions. In general, they should be as narrow as possible, but typically not less than the outside diameter of the pipe plus 250mm to allow for correct compaction of the side fill.

Minimum depth of cover for PLX should be 750mm from ground level to crown of the pipe. It is acceptable to lay pipes directly on the bottom of the trench, provided that the soil is uniform, relatively soft and fine grained and free from large flints, stones and other hard objects, which could damage the pipe wall. The trench bottom should be brought to an even finish to provide consistent support to the pipes along their complete length.

Where pipes are to be laid side by side in wide/open trenches, a minimum cover of 100mm is required and a minimum gap of 100mm should be left between pipes.

100mm thickness of selected bedding material must be placed below the pipe. Gravel or broken stone graded between five and ten millimetres in size will provide suitable bedding since it requires little compaction. Coarse sand is also acceptable provided that the particle size is not less than 3mm but care must be taken to ensure that such backfill cannot migrate as the result of high water tables. Where this possibility prevails, then the trenches must be lined with a geotextile material to prevent the migration.



Pipework must be laid to a gradient of 1:100 back to the tank. Heavy compaction equipment should not be used until the fill over the crown of the pipe is at least 300mm.

Any temporary levelling supports must be removed before the pipework is backfilled to prevent any damage to the pipe resulting from uneven settlement.

Use PLX Close-Fit Pipe Coils to reduce the number of joints required for the installation where possible.

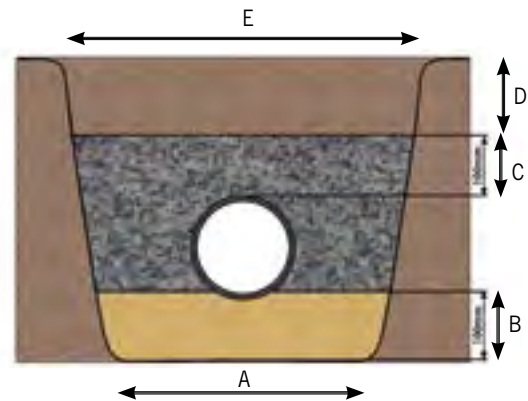

Pipe Diameter	A	B	C	D	E
110mm and below	450	100mm minimum	100mm minimum	400mm minimum	lower trench width + 600mm
150mm	450	100mm minimum	100mm minimum	400mm minimum	lower trench width + 600mm
250mm	500	100mm minimum	100mm minimum	400mm minimum	lower trench width + 600mm
315mm	600	100mm minimum	100mm minimum	400mm minimum	lower trench width + 600mm

During pipe installation a pipe cross over may be difficult to avoid. Where they occur there must be a filled space between the uppermost pipe and the one beneath. If the pipes are touching this could cause a concentrated load that may result in premature system failure or cause an uneven settlement and liquid to be trapped in system – See PLX spacing recommendations on page 27.

Size for Size Replacement

Size-for size replacement or upsizing of existing iron pipelines can be achieved with significant savings by the pipe bursting method. With this technique an existing main is cracked open and the borehole simultaneously expanded by mole. Modern pipe bursting moles – especially those with hydraulically expanding segments – can crack and open out an unserviceable pipeline, even if it has repair collars of concrete surrounds. Risk of damage to adjacent utility installations is minimised by using hydraulic moles, helping to maximise the cost advantages of using the existing 'hole in the ground'.

Sliplining

In sliplining, a replacement PLX pipe system is inserted into an existing decommissioned pipeline.

Though some reduction in flow capacity is inevitable, this can be minimised by careful preparation and cleaning of the old pipe so that the largest possible diameter of new PLX can be inserted. In many instances an average annular clearance of as little as five per cent of mains diameter – less still for sizes above 300mm – has proven adequate where pipelines are reasonably straight and of uniform bore. In pressure pipelines the reduction in carrying capacity can also be compensated for by an increase in internal pressure. In gravity applications any affect of bore reduction is minimised both by the exclusion of ground water entering the system and by the improved flow characteristics of PLX.

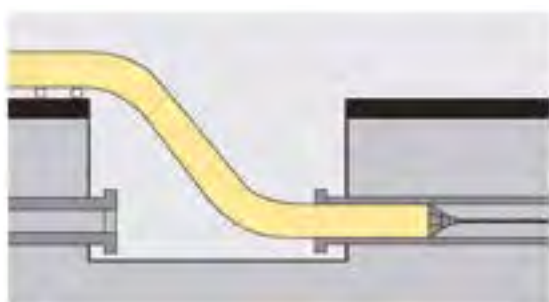

Sliplining (not to scale)

Die Draw Insertion

This method works by pulling a pre-welded string through a reducing die and into the old pipeline in one operation. Re-expansion to a close-fit diameter occurs naturally within a few hours of the wincing load being released.

Shallow and Encased Trenching

Where pipes are to be laid to shallow depths, the pipe must be protected by reinforced concrete to transfer any excessive loadings resulting from the passage of heavy vehicles. In exceptional circumstances, where pipework needs to be totally encased in concrete, the pipework should also be wrapped to prevent differential stresses being applied to the pipe.

Underground Pipe Spacing Recommendations

When installing PLX in below ground trenches there is a minimum gap requirement between each pipe being buried. If pipes are installed too close together they are unsupported by the backfill and may buckle and cause the ground to depress. Durapipe recommends the following per diameter of PLX pipes.

Pipe Outer Diameter	Gap
32-63mm	50mm
75-110mm	75mm
160mm	100mm



Above-ground Supported Installation

For exposed supported above ground pipework proper anchorage is essential. The structure and anchorages must resist or accommodate thermal stresses or movement over the ambient temperature range to which the pipe system will be subjected. Above ground PLX systems should preferably be installed at or near maximum operating temperature. In this way the pipe will be thermally expanded when clamps or supports are bolted into position – See UV protection and pipe supports section on page 54.



Expansion and Contraction

The thermal expansion of Durapipe PLX is 1.5mm/metre/10°C, which is greater than for metal. Allowance must be made for this when designing a PLX installation above ground, where significant temperature variation is expected. If the above length change is re-stated as 9mm per 6m pipe length per 10°C of temperature change, the magnitude of potential thermal movement can be better appreciated. In above ground installations the natural flexibility of the pipe, coupled with judicious siting of anchor and support brackets, will conveniently accommodate expansion and contraction at changes of direction. In installations where fully end-load bearing joints are used, the compressive or tensile forces set up in the pipeline due to constraint of thermal movement will not detract from long-term performance, but the effects of these forces on pipe support, ancillary equipment and so on, must be considered and allowances made.

The potential for thermal movement is a particular issue where (fully end-load bearing) PLX is connected to any non end-load bearing mechanically jointed system. It is essential that such transitions are securely anchored, to obviate the risk of any joints in the mechanically jointed system separating.

It is also prudent to allow a newly installed pipeline time to conform to ambient temperature before end connections are made.



UV Protection and Pipe Supports

Durapipe PLX Secondary Contained Pipe-In-Pipe systems provide excellent resistance to UV light and can be safely installed in some above ground applications. For greatest protection against accidental damage or weathering, only PLX Pipe-In-Pipe systems should be used. Pipe-In-Pipe Black PE outer pipework provides excellent resistance to UV light and only straight lengths should be used. PLX Pipe-In-Pipe should be rigidly fixed and used in conjunction with flat bar saddle clips and pipe supports should be no less than 40mm wide. Pipe clips should permit free axial movement and should not restrict expansion or contraction.



Both PLX Pipe-In-Pipe and Close-Fit systems (Close-Fit straights only), can be installed in both above and below ground, as long as the following support guides are adhered to:

Pipe-in-Pipe Support Spacing

Pipe Dimensions (mm)	Primary Pipe SDR	Support Centres (m)
32#63	11	1.0
50#90	11	1.1
63#110	11	1.2
90#160	11	1.5
110#160	11	1.5

Close-Fit Support Spacing

Pipe Dimensions (mm)	Primary Pipe SDR	Support Centres (m)
32#40	11	0.9
50#63	11	1.0
63#75	11	1.1
90#110	17	1.2
110#125	17	1.3

This table refers to straights only. If using Close-Fit coils, continuous support is required.

PLX Close-Fit pipes can be used in above (straights only) and below ground applications, either buried, or in a covered duct. If in a covered duct it can be laid on the floor of the duct, or continuously supported using an electrical cable tray or similar. After installation of the pipes a light aggregate or coarse sand is preferred as coverage.



Pipe Bending

The minimum bend radius for Durapipe PLX product lines supplied in straight lengths is 25 times the pipe outside diameter. For Secondary Containment systems the outside diameter of the outer pipe must be used as the base calculation. Electrofusion joints should not be subjected to bending stresses until they have fully cooled.

Durapipe PLX Earth Bonding Instructions

Where PLX (non-conductive) pipes are used, there is a requirement to provide earthing and bonding to equalise electrical potential of the underground piping system. Always consult a competent electrical engineer with good knowledge of local and regional rules and regulations.

Key points for effective earth establishment are: Ensure all electrofusion terminal insulating caps are correctly inserted.

All stand alone metal components such as metal backing rings attached with PE stub flanges must be earthed.

Some guidelines are:

NFPA77 – National Fire Protection Association, Recommended Practice on Static Electricity

CENELEC CLC/TR 50404 Electrostatics

Pressure Testing of PLX Product Lines Single Wall and Secondary Containment

It is important to remember that site pressure tests are carried out to determine that the installer has fused all electrofusion joints and that all threaded connections have been made.

Pressure testing to prove the suitability of the PLX system has already been carried by Durapipe at much higher pressures than would be allowed on site, during the systems design, development and subsequent approval.

Further stringent test regimes have also been performed by the many Independent Test Bodies who have certified that PLX is suitable for use as an underground pipework system for conveying liquid fuels.

Health and Safety

- Compressed air may be used to test new pipework systems.
- Nitrogen, which is an inert gas, must always be used to test existing lines where vapours or liquid fuels may still be present. The nitrogen gas will also serve to purge the pipework of any vapours and air. Site Management must always be informed when a pressure test is due to be carried out using compressed gases at these higher pressures to ensure the safety of other site personnel.
- Compressed gases occupy 3 times the volume of a given space (when compared to water) to give the equivalent pressure. Separation of any item within the system would have an explosive effect due to the sudden release of this stored energy.
- The maximum pressure of 4bar for primary (product line) and 2bar for Secondary containment should never be exceeded because of these safety concerns.

Pressure Test Guidelines

- All pressure testing equipment should be subject to manufacturers calibration requirements before use.
- All tank connections above ground or below ground should be disconnected or isolated.
- For accurate consistency of the pressure measurement it is recommended that the target pressure should be a minimum of 50% of the gauge scaling ie. a test pressure of 4bar (60psi) the gauge range to be 0 to 8bar (0 to 120psi).
- It is recommended that a suitable pressure relief valve be incorporated into the system to prevent overcharging of the pipe. This should be set at no more than 0.5bar (10psi) above the target pressure.
- When pressure testing the primary pipe, the secondary containment pipe must be open to atmosphere, this is also applicable for testing of the secondary leaving the primary pipe open to atmosphere.
- The use of compressed air is suitable as a medium for pressure testing the pipe system.
- The use of Nitrogen (from a pressure cylinder) for pressure testing of the pipe system should be applied when the pipe system has been used:
 - for pressure testing existing lines under planned maintenance procedures.
 - or if a fuel has been used to ballast a storage tank.

Pressure Testing Procedure for Primary (product) Lines

Test heads are fixed to transition fittings (at the dispenser) to allow pressure to be introduced and for the internal pressure to be measured. The other end (at the tank) must be closed off using spade connections between the compact flange/ flange connections to ensure that the tank is both isolated and that the pressure test is not also being applied to the tank.

- Introduce air/nitrogen to an initial pressure of 0.5bar (10psi).
- Examine all the electrofusion joints and threaded joints for any leakage using soap solution (where possible).
- The pressure may then be raised in 0.5bar increments over 15 minute intervals to a maximum pressure of 4.0bar (60psi).
- Once the target pressure is reached, measurements should be taken from the pressure gauge:
 - The minimum duration of test should be 1 hour.

NB: Polyethylene pipe is subject to creep under pressure and temperature. It may be necessary to apply a 'top up' to the pressure in the system after a few minutes to allow for these material fluctuations under ambient temperatures. Consideration must be made for higher temperature factors.

Pressure Testing Procedure for Secondary Containment Lines

Electrofusion Type Closures

Durapipe has designed and developed Electrofusion Short Pattern closure/ Stepped coupler fittings to fuse the outer containment pipe/fittings to the outside of the PLX product line pipes.

These fittings are designed to seal the interstice by electrofusion, and where fitted with access ports, permit connection to monitoring equipment using all the different mediums.

- Introduce air to an initial pressure of 0.5bar (10psi).
- Examine all the electrofusion joints and threaded joints for any leakage using soap solution (where possible).
- The pressure may then be raised in 0.5bar increments over 15 minute intervals to a maximum pressure of 2.0bar (30psi).
- Once the target pressure is reached, measurements should be taken from the pressure gauge:
 - The minimum duration of test should be 1 hour.

NB: Polyethylene pipe is subject to creep under pressure and temperature. It may be necessary to apply a 'top up' to the pressure in the system after a few minutes to allow for these material fluctuations under ambient temperatures. Consideration must be made for higher temperature factors.

Note:

The PLX Electrofusion Closure Fittings and the access ports are designed to allow the interstice to be monitored using over pressurization methods up to a maximum continuous working pressure of 4bar (60psi).

These fittings have been designed for use as secondary containment closure fittings only and are marked as such. They must NEVER be used to connect PLX product lines (Suction/Pressure) or PLX Fill & Vent lines.

Electrofusion Jointing

Durapipe PLX pipes and fittings are jointed by Electrofusion welding. Electrofusion is a simple, quick and easy method of jointing plastic pipe systems producing high integrity, permanent joints. Electrofusion has been an approved method of jointing polyethylene systems in the international gas and water industry for many years.

Prior to jointing, the outer surface of the PLX pipe or PLX spigot fitting must be removed. Pipe surfaces can be prepared using a PLX Pipe Preparation tool.

The PLX Multi-pipe Preparation Kit (PLX product code 43 MZO 018 (32-110mm) or 43 SPA 020 (110-225mm), is designed to mount concentric to the pipe and respective to pipe size and class interchangeable expanding mandrels and sleeves ensure the tool is held firmly in place during the peeling operation. Rotating about the pipe axis the spring loaded HSS cutter tip ensures, regardless of operator that an even amount of material is removed.

PLX spigot fittings must be scraped manually using a PLX hand scraper. Abrading the pipe end or fitting end prior to fusion is not effective in removing the outer surface. Years of experience has shown that to achieve maximum joint strength it is essential that the pipe surfaces are scraped or peeled. Prepared pipe surfaces should always be kept clean and pipe preparation should always take place immediately prior to fusion welding. If this is not possible, the prepared surface of the pipe must be covered to protect it from contamination.

If left for a period of time or dirtied both joint surfaces must be cleaned with an Isopropanol wipe before welding (PLX product code 43 451 100). Each electrofusion fitting is sealed in a bag at the point of manufacture to protect the surfaces against contamination and damage. Do not open the bag until required. Electrofusion fittings must not be scraped.

CAUTION

- **DO NOT** allow water to penetrate the joint prior to or during fusion welding
- **DO NOT** assemble or begin fusion PLX systems if either pipe ends or fitting are contaminated with any deleterious material
- **DO NOT** use near naked flames
- **DO NOT** smoke in the working area
- **DO NOT** joint in rainy conditions unless a shelter is provided to keep surfaces dry

Installation inside a building

All pipework should be installed in line with local building regulations. Generally, we do not recommend that PLX pipework is installed above ground, inside a building to carry fuel.

For installations inside a building in the UK, refer to BS 5410. Clause 8.2 which states that combustible pipework materials should not be used within 300mm of the building boundary when carrying fuel.

We recommend that any piping conveying fuel should be buried wherever possible.

Pipe Preparation Instructions

The Durapipe PLX range comprises of three systems, Single Wall, Secondary Contained Close-Fit and Pipe-In-Pipe. As these systems are different there are differences in pipe preparation.

You will need:

- PLX Pipe cutter
- PLX Pipe preparation kit and PLX hand scraper
- PLX Isopropanol Wipes
- Tape measure
- Pipe marking utensil
- Pipe protection sleeve (Close-Fit only)

All Single Wall – Primary Pipe Preparation

1. It is important to make sure the pipe is cut clean and square, a wheel cutter is best for this job. The use of a cutter ensures a square swarf-free pipe end preparation.



2. Wipe loose dirt from pipe ends.
3. Measure the fitting from the centre to the end using a tape measure. Mark the pipe, using a utensil, around the circumference, with the recorded measurement.



4. Using the PLX pipe preparation kit select the correct size mandrel to fit the pipe being prepared. Rotate the mandrel shaft anti-clockwise so that the mandrel expands and firmly grips the inside of the pipe. Using the spanner tighten the mandrel with $\frac{1}{4}$ turn.



5. Place the preparation tool onto the shaft and slide along by depressing the release button to disengage the drive until the cutter tip is aligned with the marked socket depth. Position the cutter tip approximately 1mm above the pipe surface.

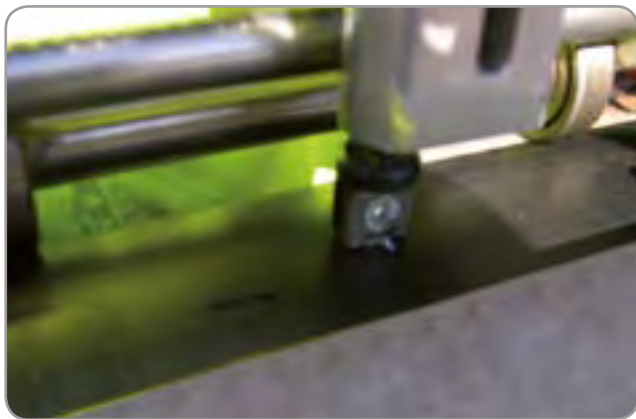

6. Apply the spring tension to the cutter tip. Then rotate the tool clockwise until the cutter has moved over the length of pipe to be prepared. A continuous ribbon of PE material should have been removed.



7. Durapipe PLX Isopropanol wipes are available to wipe the pipe surface should they become contaminated.



8. Mark the pipe again using a utensil and a tape measure or the PLX pipe fitting.



9. You can begin the electrofusion process.

Close-Fit – Pipe Preparation

1. It is important to make sure the pipe is cut clean and square, a wheel cutter is best for this job. The use of a cutter ensures a square swarf-free pipe end preparation.



2. Wipe loose dirt from pipe ends. Mark the outer pipe to approximately 150mm from the edge, using a tape measure and pipe marking utensil.



3. Manually prepare the surface of the outer pipe using a scraper, from the mark up to the end of the pipe.



4. Measure the socket depth of the primary fitting, marking this dimension plus an additional 10-15mm on the surface of the outer pipe using the marking utensil.



5. Place the PLX Pipe protection sleeve between the primary and secondary pipe.



6. Cut the pipe square using a PLX pipe cutter. The use of a cutter ensures a square swarf-free pipe end preparation.



7. Safely remove the PLX Pipe protection sleeve together with the unwanted secondary pipe.



8. Mark the pipe again using a utensil and a tape measure or the PLX pipe fitting.
9. Now proceed to follow Primary Pipe Preparation guidelines steps 1-9.

Pipe-In-Pipe – Pipe Preparation

1. Pipe-In-Pipe is supplied in a loose fit form where the primary pipe is centralised within the bigger pipe using spacers. The spacer can easily be repositioned to suit installation.



2. It is important to make sure the pipe is cut clean and square, a wheel cutter is best for this job.



3. Measure the width of the PLX Secondary Coupler.



4. Mark the outer pipe to approximately the width of the PLX Secondary Coupler, using a tape measure and pipe marking utensil.



5. Place the preparation tool onto the shaft and slide along by depressing the release button to disengage the drive until the cutter tip is aligned with the marked socket depth. Position the cutter tip approximately 1mm above the pipe surface.



6. Apply the spring tension to the cutter tip. Then rotate the tool clockwise until the cutter has moved over the length of pipe to be prepared. A continuous ribbon of PE material should have been removed.



7. Durapipe PLX Isopropanol wipes are available to wipe the pipe surface should they become contaminated.
8. Mark the pipe again using a utensil and a tape measure or the PLX pipe fitting.



9. Now proceed to follow Primary Pipe Preparation guidelines steps 1-9. Using the pipe preparation tool (for pipe sizes above 110mm use tool 43 SPA 020).

Single Wall Jointing Guide

1. Remove fitting from packaging. Place the pin mushroom caps close to where you are performing jointing.



2. Wipe the inner bore of the fitting with an isopropanol wipe ensuring it is clean only if necessary.



3. Push the fitting onto the pipe. Ensure the correct insertion and mark the position relative to the Pipe.



4. Repeat for the opposite socket and place pipe onto PLX Pipe clamp for stability.



5. Connect the leads from the electrofusion control unit to the terminals on the fitting. The lead connectors can be attached to either terminal.



6. Note the fusion time on the fitting barcode.



7. Enter the fusion time. Press the green or enter button to proceed. Durapipe offers both manual and barcode reading Electrofusion control units. The barcode reading units have a light pen, which the operator uses to input the necessary data.



8. At the end of the fusion cycle the indicator pins will have risen. Remove the electrofusion control unit leads.



9. After the cooling time is shown on the fitting barcode, insert the pin mushroom caps to prevent an accidental repeat of the fusion process.



Secondary Containment Fittings

The PLX Secondary containment system has a number of specific secondary containment fittings designed to ensure the primary system is independent to the secondary ensuring a complete leak tight system.

The PLX Secondary containment fittings range are manufactured and fabricated with the terminal shroud of the fitting reduced to fit inside the secondary spigot fitting. A flying lead is fitted to each terminal to provide connection to the electrofusion unit.

Before fusion begins, ensure that the surface of the secondary spigot fitting has been prepared using a PLX Hand scraper.

PLX Terminal Adaptors (43EW0004) are designed to connect the flying leads of the fitting to the electrofusion control unit connection leads.

The outer sleeving of the flying leads is pre-cut, but left in place to protect the wire ends from fraying. Remove this outer sleeve by twisting, inserting the 'bared' wire into the hole provided in the PLX Terminal Adaptor. The PLX Adaptor is spring loaded and requires the plunger to be squeezed in order to expose the holes and allow for the wire insertion. When released the wire will be firmly held in position. The brass end then becomes the pin for connecting to the Electrofusion control unit.

After fusion and cooling periods have elapsed, remove the PLX Terminal Adaptors. As fusion is now complete, the flying leads may be cut, as they serve no further purpose.



Close-Fit Secondary Containment Jointing Guide

It is important before you begin to follow the Pipe Preparation Guide in the previous chapter. For all Close-Fit Secondary containment Jointing PLX Closures must be used at either side of the fitting.

1. Remove fittings from packaging
2. Place pin mushroom caps close to where you are performing jointing.
3. Wipe the inner bore of the fitting with an isopropanol wipe ensuring it is clean, only if necessary.
4. Mark the socket entry depths on all the pipes.
5. Ensure that all spigot fittings are manually scraped revealing a virgin layer of PE for welding.



6. Push the fittings onto the pipes, ensuring the PLX Closure fittings are positioned on the secondary pipe, either side of the fitting. Ensure correct insertion to the marked positions for both sockets.



7. Attach the PLX terminal adaptors (43EW0004) as per guidelines below.



8. Connect the leads from the electrofusion control unit to the PLX terminal adaptors. The lead connectors can be attached to either terminal.



9. Note the fusion time on the fitting barcode.



10. Enter the fusion time. Press the green or enter button to proceed. Durapipe offers both manual and barcode reading Electrofusion control units. The barcode reading units have a light pen, which the operator uses to input the necessary data.



11. Remove the PLX terminal adaptors.

12. The flying leads may be cut as they serve no further purpose.



13. Position the secondary PLX Closures onto each side of the spigot fitting.



14. Connect the leads from the electrofusion control unit to the secondary closures.



15. Enter the fusion time. Press the green or enter button to proceed. Durapipe offers both manual and barcode reading Electrofusion control units. The barcode reading units have a light pen, which the operator uses to input the necessary data.



16. At the end of the fusion cycle the indicators will have risen.
17. After allowance of the cooling time as shown on the fitting, insert the mushroom caps to prevent an accidental repeat of the fusion process and also to insulate the terminals.



Pipe-In-Pipe Secondary Containment Jointing Guide

Before you begin, it is important to follow the Pipe Preparation Guide in the previous chapter. For all Pipe-In-Pipe Secondary Containment Jointing, PLX Secondary Couplers or PLX Closures can be used at either side of the fitting.

1. Remove fittings from packaging
2. Place pin mushroom caps close to where you are performing jointing.
3. If necessary, wipe the inner bore of the fitting with an isopropanol wipe ensuring it is clean.



4. Measure the fitting from the centre to the end using a tape measure. Mark the socket entry depths on all the pipes.



5. Push the fitting onto the pipes, ensuring the PLX Secondary Coupler is in place.



6. Ensure the correct insertion to the marked positions for both sockets.



7. Place on Pipe Clamp to ensure stability.



- 8.** Attach the PLX terminal adaptors (43EW0004) as per guidelines below.



- 9.** Connect the leads from the electrofusion control unit to the PLX terminal adaptors. The lead connectors can be attached to either terminal.



- 10.** Note the fusion time on the fitting barcode.

- 11.** Enter the fusion time. Press the green or enter button to proceed. Durapipe offers both manual and barcode reading Electrofusion control units. The barcode reading units have a light pen, which the operator uses to input the necessary data.

- 12.** Remove the PLX terminal adaptors.



- 13.** The flying leads may be tucked into the space between the primary and secondary pipes, or they can be cut as they serve no further purpose.



14. Remove the primary pipe clamps and push the secondary pipes together and pull over the PLX Secondary Coupler into place.

15. Note the fusion time on the fitting barcode.



16. Enter the fusion time by using the up and down buttons. Press the green button to proceed. Durapipe offers both manual and barcode reading Electrofusion control units. The barcode reading units have a light pen, which the operator uses to input the necessary data.



17. At the end of the fusion cycle the indicators will have risen.



18. After allowance of the cooling time as shown on the fitting, insert the mushroom caps to prevent an accidental repeat of the fusion process and also to insulate the terminals.



Single Wall



Features

- Polyethylene composite material
- Protective barrier co-extruded bore layer
- Polyethylene black outer skin
- Fusion welded system
- Available in straights and coils
- EN 14125 fully accredited
- Semi-flexible pipework

Benefits

- Safe and durable (30 year design life)
- Resists permeation and anti-clogging properties
- UV resistant
- Fast, simple jointing
- Easy installation and minimal jointing

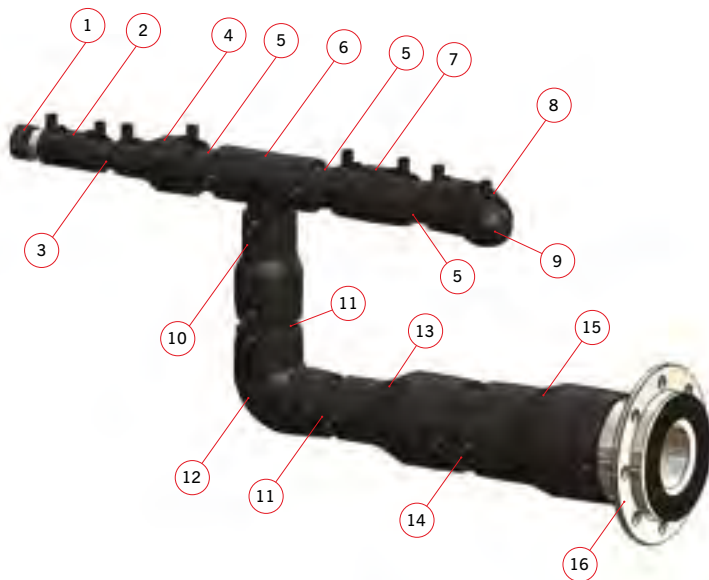

NUMBER	PART CODE	DESCRIPTION
1	43394308	PLX 32 x 1 inch Female Transition
2	43100308	PLX 32 mm E/F Coupler
3	43626308	PLX 32 mm SDR11 Pipe 6 metre
4	43402414	PLX 32 x 50 mm Reducer
5	43626310	PLX 50 mm SDR11 Pipe 6 metre
6	43408310	PLX 50 mm Equal Tee
7	43100310	PLX 50 mm Coupler
8	43105310	PLX 50 mm 45 Elbow
9	43233310	PLX 50 mm SDR11 Spigot End Cap
10	43402444	PLX 50 x 63 mm Reducer
11	43626311	PLX 63 mm SDR11 Pipe 6 metre
12	43104311	PLX 63 mm 90 Elbow
13	43402459	PLX 90 x 63 mm Reducer
14	43626313	PLX 90 mm SDR11 Pipe 6 metre
15	43402483	PLX 90 x 110 mm Reducer
16	43271314	PLX 110 mm Stub Flange Transition

PIPE

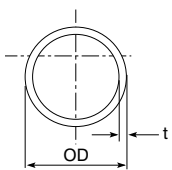
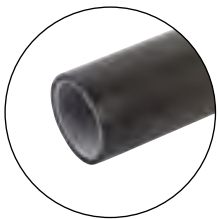

Single Wall Pipe SDR11 Straights - 10bar

Size OD mm	Length m	Code	t (min)	Pack QTY	Pack Size (w) x (h)	Item Weight kg
32	6	43 626 308	3	116	0.6 x 0.55	1.6
50	6	43 626 310	4.6	106	0.65 x 0.6	4.0
63	6	43 626 311	5.8	68	0.7 x 0.67	6.3
90	6	43 626 313	8.2	34	0.74 x 0.64	12.9
110	6	43 626 314	10	23	0.75 x 0.65	19.2
160	6	43 626 317	14.6	9	0.76 x 0.68	40.5
225	6	43 626 320	20.5	11	1.24 x 0.9	79.8
315	6	43 626 323	28.6	8	1.06 x 0.95	155.4

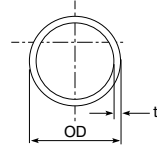
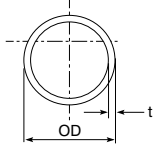
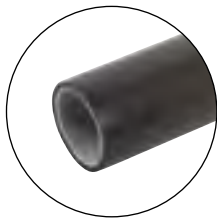

Single Wall Pipe SDR11 Coils - 10bar

Size OD mm	Length m	Code	t (min)	Pack QTY	Pack Size (w) x (d)	Item Weight kg
32	50	43 614 308	3	1	1.3 x 0.22	13.4
50	50	43 614 310	4.6	1	1.7 x 0.16	33.4
63	50	43 614 311	5.8	1	1.7 x 0.26	52.6
32	100	43 615 308	3	1	1.3 x 0.26	26.7
50	100	43 615 310	4.6	1	1.8 x 0.22	67.2
63	100	43 615 311	5.8	1	1.95 x 0.37	105.2

Single Wall Gravity Fill & Vent Pipe SDR17 - 4bar

Size OD mm	Length m	Code	t (min)	Pack QTY	Pack Size (w) x (h)	Item Weight kg
63	6	43 609 311	3.6	68	0.7 x 0.67	6.3
90	6	43 609 313	5.4	34	0.74 x 0.64	8.3
110	6	43 609 314	6.6	23	0.75 x 0.65	13.1

FITTINGS

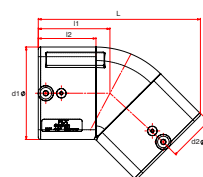
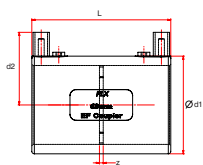

Single Wall Coupler 39.5v - 10bar

Size OD mm	Code	L (mm)	d1 (mm)	d2 (mm)	z (mm)	Box QTY	Item Weight kg
32	43 100 308	83	44	39	2	200	0.1
50	43 100 310	98	65	50	3	110	0.1
63	43 100 311	111	78	58	3	80	0.2
90	43 100 313	127	119	74	3	36	0.6
110	43 100 314	135	141.5	82	3	22	0.8
160	43 100 317	164	198	113	-	8	1.8
225	43 100 320	224	278	149	-	2	3.9
315	43 100 323	300	390	195	-	2	10.1

Single Wall 45° Elbow 39.5v - 10bar

Size OD mm	Code	L (mm)	l1 (mm)	l2 (mm)	d1 (mm)	d2 (mm)	Box QTY	Item Weight kg
32	43 105 308	83	48	40	42	38	115	0.1
50	43 105 310	99	57	45	66	50	60	0.2
63	43 105 311	113	65	50	80	57	22	0.3
90	43 105 313	154	89	69	115	75	18	0.7
110	43 105 314	172	99	70	136	85	9	1.0
160	43 105 317	377	274	92	207	104	1	4.4
225	43 105 320	450	310	111	280	140	1	8.3
315	43 105 323	755	557	151	396	198	1	36.0

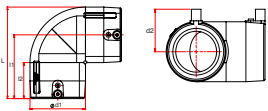

Single Wall 90° Elbow 39.5v - 10bar

Size OD mm	Code	L (mm)	I1 (mm)	I2 (mm)	d1 (mm)	d2 (mm)	Box QTY	Item Weight kg
32	43 104 308	82	60	40	42	38	115	0.1
50	43 104 310	113	80	50	65	49	63	0.2
63	43 104 311	130	91	54	78	56	45	0.4
90	43 104 313	181	126	69	111	72	20	0.9
110	43 104 314	210	142	71	136	85	9	1.3
160	43 104 317	329	226	92	207	104	3	4.9
225	43 104 320	430	290	113	280	140	1	10.2
315	43 104 323	677	479	151	396	198	1	40.0

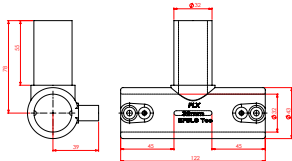

Single Wall Equal Tee (Spigot Branch) 39.5v - 10bar

Size OD mm	Code	L (mm)	I1 (mm)	h (mm)	d1 (mm)	Box QTY	Item Weight kg
32	43 408 308	122	45	78	43	70	0.1
50	43 408 310	133	46	93	65	40	0.3
63	43 408 311	154	51	111	78	24	0.4
90	43 408 313	218	65	146	111	9	1.1
110	43 408 314	238	71	167	136	6	1.7

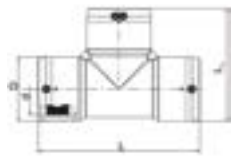

Single Wall Equal 3-Way EF Tee 39.5v - 10bar

Size OD mm	Code	L (mm)	I1 (mm)	h (mm)	D (mm)	Box QTY	Item Weight kg
160	43 408 317	430	315	215.5	200	3	5.8
225	43 408 320	580	430	290	280	1	13.9
315	43 408 323	940	670	472	396	1	55.9

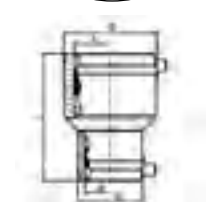

Single Wall Reducer 39.5v - 10bar

Size OD mm	Code	L (mm)	D1 (mm)	d1 (mm)	D2 (mm)	d2 (mm)	Box QTY	Item Weight kg
32 x 50	43 402 414	110	68	50	45	32	32	0.1
32 x 63	43 402 415	125	82	63	45	32	18	0.2
50 x 63	43 402 444	125	82	63	68	50	16	0.2
63 x 90	43 402 459	160	117	90	82	63	15	0.5
90 x 110	43 402 483	180	140	110	115	90	8	0.9
110 x 160	43 402 495	230	201	160	140	110	8	2.0



Single Wall Spigot End Caps - Various SDR

Size OD mm	Code	SDR	L (mm)	Box QTY	Item Weight kg
32	43 233 308	11	55	50	0.1
50	43 233 310	11	90	30	0.1
63	43 233 311	11	95	15	0.2
90	43 232 313	17*	109	6	0.5
110	43 232 314	17*	122	6	0.9

* Please note that although the fitting is 10bar rated, when used in conjunction with a SDR17 4bar pipe this will result in a 4bar system.

TRANSITIONS



Single Wall EF Female BSP 39.5v - 10bar

Size OD mm	Code	L (mm)	I1 (mm)	I2 (mm)	d1 (mm)	d2 (mm)	Box QTY	Item Weight kg
32 x 1"	43 394 308	122	83	40.5	44	39	10	0.7
50 x 1½"	43 741 310	139.5	107	63.5	73	53	6	0.7
63 x 1½"	43 741 628	140.5	108	64.5	85	59.5	6	0.9
63 x 2"	43 741 311	140.5	108	64.5	85	59.5	6	1.1



Single Wall EF Female Compact Flange BSP 39.5v - 10bar

Size OD mm	Code	L (mm)	I1 (mm)	I2 (mm)	d1 (mm)	d2 (mm)	Box QTY	Item Weight kg
50 x 1½"	43 742 310	160.5	128.5	63.5	91	52.8	6	3.3
63 x 2"	43 742 311	161.5	129.5	64.5	102	60.5	6	4.0



Single Wall Spigot Female BSP - 10bar

Size OD mm	Code	L (mm)	I1 (mm)	I2 (mm)	d1 (mm)	d2 (mm)	Box QTY	Item Weight kg
50 x 1½"	43 719 310	135.5	103	58	73	36.5	6	0.7
63 x 1½"	43 719 628	142.5	110	65	73	36.5	6	0.8
63 x 2"	43 719 311	142.5	110	65	85	42.5	20	1.0
90 x 3"	43 483 313	180	130	80	99	49.5	20	6.0
110 x 4"	43 483 314	203	150	80	131	65.5	20	7.5



Single Wall Spigot Male BSP - 10bar

Size OD mm	Code	L (mm)	I1 (mm)	I2 (mm)	d1 (mm)	d2 (mm)	Box QTY	Item Weight kg
50 x 1½"	43 723 310	160.5	103	58	73	36.5	6	1.1
63 x 1½"	43 723 628	167.5	110	65	73	36.5	6	1.2
63 x 2"	43 723 311	167.5	110	65	73	36.5	20	1.1
90 x 3"	43 480 313	209	120	70	100	50	20	6.0
110 x 4"	43 480 314	244	140	85	121	60.5	20	7.5



Single Wall Spigot Female Compact Flange BSP - 10bar

Size OD mm	Code	L (mm)	I1 (mm)	I2 (mm)	d1 (mm)	d2 (mm)	Box QTY	Item Weight kg
50 x 1½"	43 721 310	157	125	58	73	77	20	3.1
63 x 2"	43 721 311	164	132	65	85	83	20	4.0
90 x 3"	43 484 313	226	135	85	100	115	20	6.5
110 x 4"	43 484 314	211	145	75	125	145	20	8.0

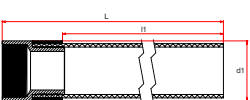

Single Wall Long Spigot Female Extended BSP - 10bar

Size OD mm	Code	L (mm)	I1 (mm)	I2 (mm)	d1 (mm)	d2 (mm)	Box QTY	Item Weight kg
50 x 1½"	43 481 310	838	805	760	73	58	??	3.6
63 x 1½"	43 481 628	838	805	760	73	58	20	4.0
63 x 2"	43 481 311	838	805	760	85	70	20	4.0

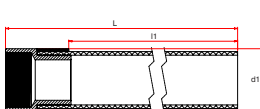

Single Wall Long Spigot Female Extended BSP Fill & Vent - 4bar

Size OD mm	Code	L (mm)	I1 (mm)	I2 (mm)	d1 (mm)	d2 (mm)	Box QTY	Item Weight kg
90 x 3"	43 735 313	800	750	700	99	49.5	20	6.0
110 x 4"	43 735 314	803	750	680	131	65.5	20	7.5

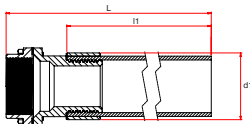
Single Wall Long Spigot Female Compact Flange Extended BSP - 4bar (also Fill & Vent)

Size OD mm	Code	L (mm)	I1 (mm)	I2 (mm)	d1 (mm)	d2 (mm)	Box QTY	Item Weight kg
50 x 1½"	43 482 310	854	802	755	73	58	6	3.3
63 x 2"	43 482 311	854	802	755	85	83	20	4.0
90 x 3"	43 736 313	841	750	700	100	115	20	6.5
110 x 4"	43 736 314	816	750	680	125	145	20	8.0

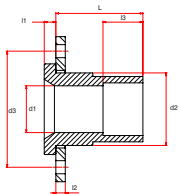
Single Wall Stub Flange - 10bar (Zinc plated mild steel backing ring)

Size OD mm	Code	L (mm)	I1 (mm)	I2 (mm)	I3 mm	d1 (mm)	d2 (mm)	d3 mm	d4 flange?	d5 flange?	Box QTY	Item Weight kg
50 (40NW)	43 271 310	100	10	45	6	32.5	60	110	150	18	50	1.1
63 (50NW)	43 271 311	115	10	50	8	44	74	125	165	18	50	1.6
90 (80NW)	43 271 313	136	16	55	13	65	100	160	200	18	10	2.3
110 (100NW)	43 271 314	156	16	63	13	77	125	180	220	18	5	2.8

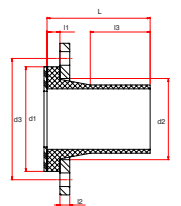
Single Wall SDR11 PE Stub Flange Assembly - 10bar (Galvanised Mild Steel backing ring)

Size OD mm	Code	L (mm)	I1 (mm)	I2 (mm)	I3 (mm)	d1 (mm)	d2 (mm)	Box QTY	Item Weight kg
50 (40NW)	43 329 310	90	12	8	62	88	110	12	1.0
63 (50NW)	43 329 311	106	14	8	70	102	124	10	1.7
90 (80NW)	43 329 313	140	17	8	100	138	160	7	2.4
110 (100NW)	43 329 314	160	18	8	113	158	180	5	2.9
160 (150NW)	43 329 317	208	25	12	155	212	234	3	7.3
225 (200NW)	43 329 320	201	32	12	135	268	290	1	9.6
315 (300NW)	43 329 323	239	35	14	158	370	392	1	23.4

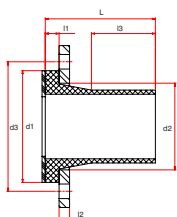
Single Wall SDR17 PE Stub Flange Assembly - 4bar (Galvanised Mild Steel backing ring)

Size OD mm	Code	L (mm)	I1 (mm)	I2 (mm)	I3 (mm)	d1 (mm)	d2 (mm)	Box QTY	Item Weight kg
90 (80NW)	43 328 313	140	17	8	100	138	160	7	2.3
110 (100NW)	43 328 314	160	18	8	113	158	180	5	2.8

Close-Fit



Features

- Polyethylene composite material
- Protective barrier co-extruded bore layer
- Polyethylene black outer skin with red stripes
- Fusion welded system
- Available in straights and coils
- EN 14125 fully accredited
- 360° secondary contained system
- Semi-flexible pipework

Benefits

- Safe and durable (30 year design life)
- Resists permeation and anti-clogging properties
- UV resistant
- Allows for interstitial monitoring and leak detection
- Fast, simple jointing
- Easy installation and minimal jointing

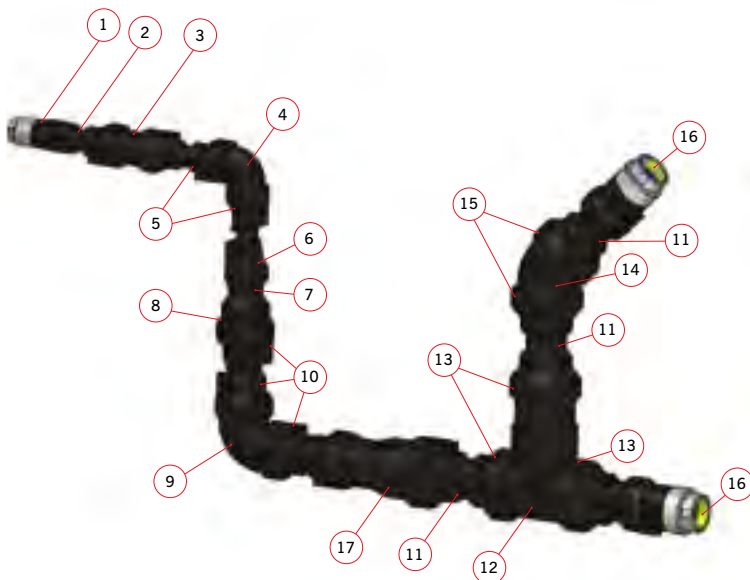

NUMBER	PART CODE	DESCRIPTION
1	43750413	PLX 32-40 x 1 inch Close-Fit Female Trans inc Test Port
2	43664413	PLX 32-40mm Close-Fit Pipe 6 metre
3	43249308	PLX 32-40mm Close-Fit Pipe Joiner
4	43248308	PLX 32-63mm 90° Elbow
5	43278430	PLX 40-63mm Slip Closure
6	43343308	PLX 32-40 x 50-63mm Close-Fit Reducer
7	43664444	PLX 50-63mm Close-Fit Pipe 6 metre
8	43343310	PLX 50-63 x 63-75mm Close-Fit Reducer
9	43248310	PLX 50-90mm 90° Elbow
10	43278459	PLX 63-90mm Slip Closure
11	43664445	PLX 63-75mm Close-Fit Pipe 6 metre
12	43246311	PLX 63-110mm Equal Tee
13	43278472	PLX 75-110mm Slip Closure
14	43250311	PLX 63-110mm 45° Elbow
15	43278472	PLX 75-110mm Slip Closure
16	43749445	PLX 63-75 x 2inch Close-Fit Female Transition
17	43249311	PLX 63-75mm Close-Fit Pipe Joiner

PIPE

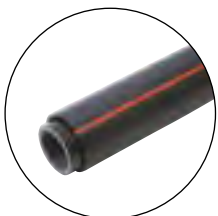

Close-Fit Pipe SDR11#26 Straights - 10bar Primary, 4bar Secondary

Size OD mm	Length m	Code	t (min)	t1 (min)	Pack QTY	Pack Size (w) x (h)	Item Weight kg
32#40	6	43 664 413	1.5	2.9	50	0.4 x 0.5	3.5
50#63	6	43 664 444	2.4	4.5	68	0.7 x 0.67	7.1
63#75	6	43 664 445	2.9	5.8	46	0.73 x 0.63	10.5

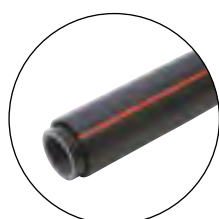
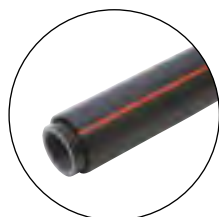

Close-Fit Pipe SDR11#26 Coils - 10bar Primary, 4bar Secondary

Size OD mm	Length m	Code	t (min)	t1 (min)	Pack QTY	Pack Size (w) x (h)	Item Weight kg
32#40	50	43 624 413	1.5	2.9	1	1.5 x 0.17	29.5
50#63	50	43 624 444	2.4	4.5	1	1.8 x 0.26	58.9
63#75	50	43 624 445	2.9	5.8	1	1.7 x 0.4	87.6
32#40	100	43 649 413	1.5	2.9	1	1.5 x 0.25	59.0
50#63	100	43 649 444	2.4	4.5	1	2.0 x 0.32	118.2
63#75	100	43 649 445	2.9	5.8	1	2.1 x 0.42	175.0

Close-Fit Fill & Vent Pipe SDR17#26 Straights - 4bar Primary, 4bar Secondary

Size OD mm	Length m	Code	t (min)	t1 (min)	Pack QTY	Pack Size (w) x (h)	Item Weight kg
90#110	6	43 665 446	4.2	5.3	23	0.75 x 0.65	15.1
110#125	6	43 665 447	4.8	6.5	18	0.73 x 0.7	24.6

FITTINGS

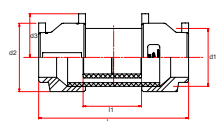

Close-Fit Joiner 39.5v - 10bar

Size OD mm	Code	L (mm)	l1 (mm)	d1 (mm)	d2 (mm)	Box QTY	Item Weight kg
32#40	43 249 308	201	97	63	83	15	0.6
50#63	43 249 310	250	124	90	98	10	0.8
63#75	43 249 311	285	148	110	130	10	1.2
90#110	43 249 313	304	204	160	127	3	3.8
110#125	43 249 314	286	204	160	135	5	3.9

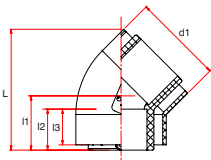

Secondary Contained 45° Elbow 39.5v - 10bar*

System Reference Size (mm)	Elbow Size (mm)	Code	L (mm)	I1 (mm)	I2 (mm)	I3 (mm)	d1 (mm)	Box QTY	Item Weight kg	Closures Required
32#40	32#63	43 250 308	84	50	42	40	63	25	0.1	2 x 43 278 430
50#63	50#90	43 250 310	99	58	45	42	90	25	0.3	2 x 43 278 459
63#110	63#110	43 250 311	113	66	50	44	110	20	0.5	2 x 43 278 472
90#110	90#160	43 262 313	240	108	86	69	160	6	1.4	2 x 43 278 475
110#125	110#160	43 262 314	240	108	82	70	160	6	1.7	2 x 43 278 476

* (2 no. additional closures required to complete Close-Fit elbow)

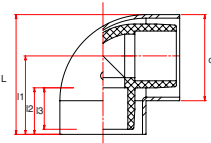

Secondary Contained 90° Elbow 39.5v - 10bar*

System Reference Size (mm)	Elbow Size (mm)	Code	L (mm)	I1 (mm)	I2 (mm)	I3 (mm)	d1 (mm)	Box QTY	Item Weight kg	Closures Required
32#40	32#63	43 248 308	96	45	40	40	63	25	0.2	2 x 43 278 430
50#63	50#90	43 248 310	128	53	50	42	90	25	0.4	2 x 43 278 459
63#110	63#110	43 248 311	153	100	60	53	110	20	0.9	2 x 43 278 472
90#110	90#160	43 263 313	235	155	103	69	160	5	1.8	2 x 43 278 475
110#125	110#160	43 263 314	235	135	93	71	160	5	2.2	2 x 43 278 476

* (2 no. additional slip closures required to complete Close-Fit elbow)

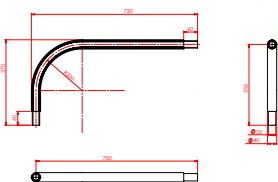

Close-Fit Hockey Stick SDR11#26 - 10bar Primary, 4bar Secondary

Size OD mm	Code	L (mm)	I1 (mm)	d1 (mm)	Box QTY	Item Weight kg
32#40	43 338 308	720	370	40	10	0.6

MTO

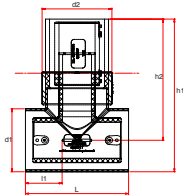

Secondary Contained Equal Tee 39.5v - 10bar*

System Size (mm)	Elbow Size (mm)	Code	L (mm)	I1 (mm)	h1 (mm)	h2 (mm)	Box QTY	Item Weight kg	Closures Required
32#40	32#63	43 246 308	140	54	70	156.5	10	0.5	3 x 43 278 430
50#63	50#90	43 246 310	160	60	247	202	10	0.9	3 x 43 278 459
63#110	63#110	43 246 311	180	64	266	212	10	1.4	3 x 43 278 472

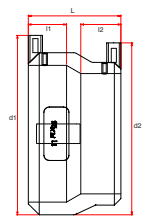

Secondary Contained Slip Closure 39.5v - 4bar

Size OD mm	Code	L (mm)	I1 (mm)	I2 (mm)	d1 (mm)	d2 (mm)	Box QTY	Item Weight kg
32#40	43 278 413	69	29	33	74	74	40	0.1
40#63	43 278 430	78	28	31	99	99	45	0.1
50#63	43 278 444	67	27	29	99	99	30	0.2
63#75	43 278445	67	27	29	110	113	20	0.2
63#90	43 278 459	84	34	34	126	126	25	0.2
75#110	43 278 472	89	34	34	148	130	20	0.3
90#110	43 278 473	87	35	34	148	138	10	0.3
110#125	43 278 474	85	35	37	165	158	10	0.4
110#160	43 278 475	113	34	35	204	179	6	0.7
125#160	43 278 476	100	34	35	204	188	8	0.6

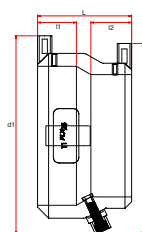

Secondary Contained Slip Closure with 1/8" BSP Access Port 39.5v - 4bar

Size OD mm	Code	L (mm)	I1 (mm)	I2 (mm)	d1 (mm)	d2 (mm)	Box QTY	Item Weight kg
32#40	43 279 413	69	29	33	92	92	40	0.3
40#63	43 279 430	78	28	31	116	113	45	0.3
50#63	43 279 444	67	27	29	116	116	30	0.3
63#75	43 279445	67	27	29	129	121	20	0.2
63#90	43 279 459	84	34	34	143	143	15	0.4
75#110	43 279 472	89	34	34	165	148	8	0.5
90#110	43 279 473	87	35	34	162	152	10	0.4
110#125	43 279 474	85	35	37	180	173	10	0.5
110#160	43 279 475	113	34	35	204	179	5	0.8
125#160	43 279 476	100	34	35	209	193	7	0.8

TRANSITIONS

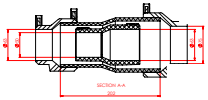

Close-Fit Reducer 39.5v - 10bar

Size OD mm	Code	L (mm)	I1 (mm)	d1 (mm)	d2 (mm)	d3 (mm)	Box QTY	Item Weight kg
32#40 x 50#63	43 343 308	329	224	110	99	111	5	1.4
50#63 x 63#75	43 343 310	307	202	110	95	111	5	2.0

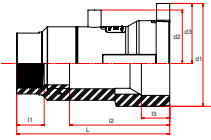

Close-Fit EF Female BSP 39.5v - 10bar

Size OD mm	Code	L (mm)	I1 (mm)	I2 (mm)	I3 mm	d1 (mm)	d2 (mm)	d3 mm	Box QTY	Item Weight kg
32#40 x 1"	43 749 413	130	17	90	26	76	44	48	6	0.5
50#63 x 1½"	43 749 444	151	27	99	28	102	53	59	6	0.5
63#75 x 2"	43 749 445	151	27	99	30	116	59	65	6	0.9

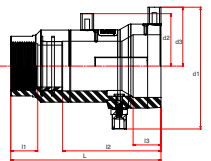

Close-Fit EF Female BSP with Test Port 39.5v - 10bar

Size OD mm	Code	L (mm)	I1 (mm)	I2 (mm)	I3 mm	d1 (mm)	d2 (mm)	d3 mm	Box QTY	Item Weight kg
32#40 x 1"	43 750 413	130	17	90	26	97	44	48	6	6.0
50#63 x 1½"	43 750 444	151	27	99	28	123	53	59	6	0.7
63#75 x 2"	43 750 445	151	27	99	30	123	59	65	6	1.0



Single Wall EF Female Compact Flange BSP 39.5v - 10bar

Size OD mm	Code	L (mm)	I1 (mm)	I2 (mm)	d1 (mm)	d2 (mm)	Box QTY	Item Weight kg
50 x 1½"	43 742 310	160.5	128.5	63.5	91	52.8	6	3.3
63 x 2"	43 742 311	161.5	129.5	64.5	102	60.5	6	4



Single Wall Spigot Female Compact Flange BSP - 10bar

Size OD mm	Code	L (mm)	I1 (mm)	I2 (mm)	d1 (mm)	d2 (mm)	Box QTY	Item Weight kg
50 x 1½"	43 721 310	157	125	58	73	77	20	3.1
63 x 2"	43 721 311	164	132	65	85	83	20	4.0
90 x 3"	43 484 313	226	135	85	100	115	20	6.5
110 x 4"	43 484 314	211	145	75	125	145	20	8

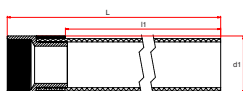

Single Wall Spigot Female Extended BSP Fill & Vent - 4bar

Size OD mm	Code	L (mm)	I1 (mm)	d1 (mm)	Box QTY	Item Weight kg
90 x 3"	43 735 313	800	700	99	20	6.0
110 x 4"	43 735 314	803	750	131	20	7.5

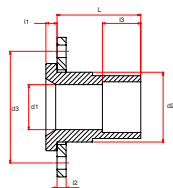

Single Wall SDR11 Stub Flange - 10bar

Size OD mm	Code	L (mm)	I1 (mm)	I2 (mm)	I3 (mm)	d1 (mm)	d2 (mm)	Box QTY	Item Weight kg
63 (50NW)	43 271 311	115	10	8	55	44	125	50	1.6
90 (80NW)	43 271 313	136	17	13	79	79	160	10	2.3
110 (100NW)	43 271 314	156	18	9	82	82	180	5	2.8

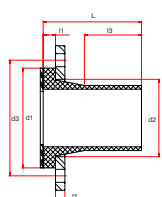

Single Wall PE Stub Flange Assembly - SDR11 - 10bar. SDR17 = 4bar

Size OD mm	Code	SDR	L (mm)	I1 (mm)	I2 (mm)	I3 (mm)	d1 (mm)	d2 (mm)	Box QTY	Item Weight kg
63 (50NW)	43 329 313	11	117	14	8	63	102	125	10	1.7
90 (80NW)	43 328 313	17	136	17	8	79	138	160	7	2.3
110 (100NW)	43 328 314	17	136	18	8	82	158	180	5	2.8

Pipe-in-Pipe



Features

- Polyethylene composite material
- Protective barrier co-extruded bore layer
- Polyethylene black outer skin
- Fusion welded system
- Available in straights and coils
- EN 14125 fully accredited
- 360° secondary contained system
- Rigid pipework

Benefits

- Safe and durable (30 year design life)
- Resists permeation and anti-clogging properties
- UV resistant
- Allows for interstitial monitoring and leak detection
- Fast, simple jointing
- Easy installation and minimal jointing
- Ideal for above ground applications

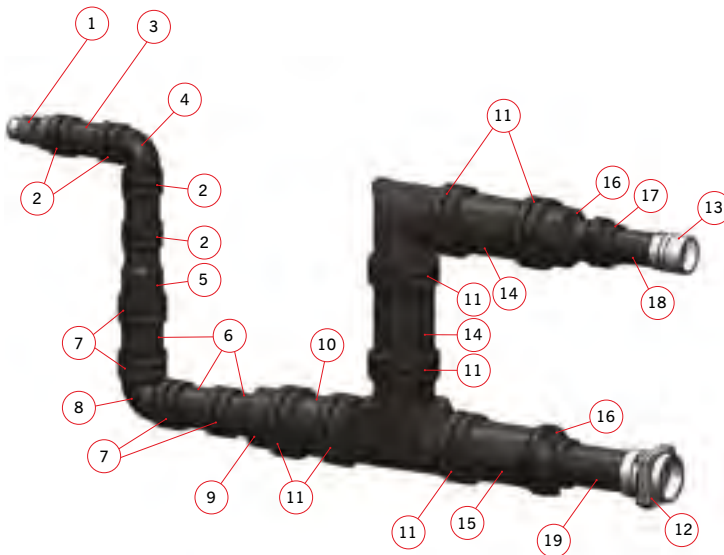

NUMBER	PART CODE	DESCRIPTION
1	43356310	PLX 50-90 x 1 1/2 inch Spigot Pipe-in-Pipe Female Trans.
2	43110313	PLX 90mm Slip Coupler
3	43601310	PLX 50-90mm Pipe-in-Pipe 6 metre
4	43248310	PLX 50-90mm 90° Elbow
5	43342310	PLX 50-90 x 63-110mm Pipe-in-Pipe Reducer
6	43601311	PLX 63-110mm Pipe-in-Pipe 6 metre
7	43110314	PLX 110mm Slip Coupler
8	43248311	PLX 63-110mm 90° Elbow
9	43342311	PLX 63-110 x 90-160mm Pipe-in-Pipe Reducer
10	43601313	PLX 90-160mm Pipe-in-Pipe 6 metre
11	43110317	PLX 160mm Slip Coupler
12	43736314	PLX 110 x 4 inch S/W Fill and Vent Spigot Fern Comp Flange Ext Trans
13	43735313	PLX 90 x 3 inch S/W Fill and Vent Spigot Fem Ext Trans
14	43601313	PLX 90-160mm S/C Pipe-in-Pipe 6 metre
15	43601314	PLX 110-160mm S/C Pipe-in-Pipe 6 metre
16	43278475	PLX 110-160mm E/F Slip Closure
17	43278473	PLX 90-110mm E/F Slip Closure
18	43626313	PLX 90mm SDR11 S/W Pipe 6 metre
19	43626314	PLX 110mm SDR11 S/W Pipe 6 metre

PIPE

Pipe-in-Pipe Straights - 10bar Primary, 4bar Secondary

Size OD mm	Length m	Code	t (min)	t1 (min)	Pack QTY	Pack Size (w) x (h)	Item Weight kg
32#63	6	43 601 308	3.7	2.9	68	0.7 x 0.67	8.2
50#90	6	43 601 310	5.3	4.6	34	0.74 x 0.64	13.8
63#110	6	43 601 311	4.3	5.8	18	0.75 x 0.65	15.0
90#160	6	43 601 313	6.2	8.2	9	0.9 x 0.52	32.1
110#160	6	43 601 314	6.2	10	9	0.9 x 0.52	38.4
160#225	6	43 601 317	8.7	14.6	7	1 x 0.65	151.6

Larger sizes available upon request



Secondary Contained Primary Coupler with Leads 39.5v - 10bar

System Reference Size mm	Size OD mm	Code	L (mm)	d1 (mm)	d2 (mm)	z (mm)	Box QTY	Item Weight kg
32#63	32	43 101 308	83	44	26	2	200	0.1
50#90	50	43 101 310	98	65	36.5	3	110	0.1
63#110	63	43 101 311	111	78	43	3	80	0.2
90#160	90	43 101 313	127	119	61.5	3	36	0.6
110#160	110	43 101 314	135	141.5	73	3	22	0.1
160#225*	160	43 101 317	164	198	100	-	8	1.8

*No flying leads required

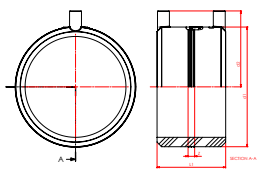

Pipe-in-Pipe Secondary Slip Coupler 39.5v - 4bar

System Reference Size mm	Size OD mm	Code	L (mm)	d1 (mm)	d2 (mm)	Box QTY	Item Weight kg
32#63	63	43 110 311	111	79	60	45	0.1
50#90	90	43 110 313	127	119	61.5	24	0.2
63#110	110	43 110 314	135	141.5	73	25	0.3
90#160	160	43 110 317	164	198	108	18	0.5
110#160	160	43 110 317	164	198	108	18	0.5
160#225	225	43 110 320	270	184	114	1	14.5

Pipe-in-Pipe Reducer 39.5v - 10bar

Size OD mm	Code	L (mm)	l1 (mm)	d1 (mm)	d2 (mm)	d3 (mm)	d4 (mm)	Box QTY	Item Weight kg
32#63 x 50#90	43 342 308	314	200	90	50	63	32	5	0.8
50#90 x 63#110	43 342 310	333	202	110	63	90	50	5	1.3
63#110 x 90#160	43 342 311	400	250	160	90	110	63	3	2.7
90#160 x 110#160	43 342 313	414	250	160	110	90	-	2	2.0

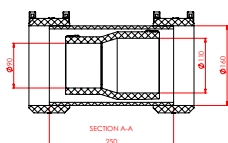

Secondary Contained 45° Elbow 39.5v - 10bar*

Elbow Size mm	Code	L (mm)	l1 (mm)	l2 (mm)	l3 (mm)	d1 (mm)	Box QTY	Item Weight kg	Slip Couplers Required
32#63	43 250 308	84	50	42	40	63	25	0.1	2 x 43 110 311
50#90	43 250 310	99	58	45	42	90	25	0.3	2 x 43 110 313
63#110	43 250 311	113	66	50	44	110	20	0.5	2 x 43 110 314
90#160	43 262 313	240	108	86	69	160	6	1.4	2 x 43 110 317
110#160	43 262 314	240	108	82	70	160	6	1.7	2 x 43 110 317

*2 no. additional slip couplers to complete Pipe-in-Pipe elbow

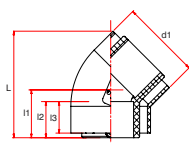



Double Spigot Secondary Contained 45° Elbow - 10bar*

Elbow Size mm	Code	L (mm)	I1 (mm)	I2 (mm)	I3 (mm)	I4 (mm)	Box QTY	Item Weight kg	Slip Couplers Required	Primary Couplers Required
160#225	43 997 323	561	456	448	344	90	1	8.0	2 x 43 110 320	2 x 43 101 317

* 2 no. additional slip couplers 2 no. additional primary couplers to complete Pipe-in-Pipe tee

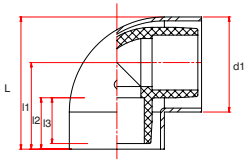

Secondary Contained 90° Elbow 39.5v - 10bar*

Elbow Size mm	Code	L (mm)	I1 (mm)	I2 (mm)	I3 (mm)	d1 (mm)	Box QTY	Item Weight kg	Slip Couplers Required
32#63	43 248 308	96	45	40	??	63	25	0.2	2 x 43 110 311
50#90	43 248 310	128	53	50	??	90	25	0.4	2 x 43 110 313
63#110	43 248 311	153	100	60	53	110	20	0.9	2 x 43 110 314
90#160	43 263 313	235	155	103	69	160	5	1.8	2 x 43 110 317
110#160	43 263 314	235	135	93	71	160	5	2.2	2 x 43 110 317

* 2 no. additional slip couplers to complete Pipe-in-Pipe elbow



Double Spigot Secondary Contained 90° Elbow - 10bar*

Elbow Size mm	Code	L (mm)	I1 (mm)	I2 (mm)	I3 (mm)	I4 (mm)	Box QTY	Item Weight kg	Slip Couplers Required	Primary Couplers Required
160#225	43 997 322	561	456	448	344	90	1	14.0	2 x 43 110 320	2 x 43 101 317

* 2 no. additional slip couplers 2 no. additional primary couplers to complete Pipe-in-Pipe tee

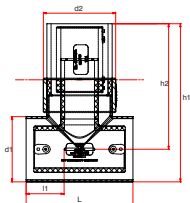

Secondary Contained Equal Tee 39.5v - 10bar*

Elbow Size mm	Code	L (mm)	l1 (mm)	h1 (mm)	h2 (mm)	Box QTY	Item Weight kg	Slip Couplers Required
32#63	43 246 308	140	54	70	156.5	10	0.5	3 x 43 110 311
50#90	43 246 310	160	60	247	202	10	0.9	3 x 43 110 313
63#110	43 246 311	180	64	266	212	10	1.4	3 x 43 110 314

* 3 no. additional slip couplers to complete Pipe-in-Pipe tee



Secondary Contained Double Spigot Equal Spigot Tee - 10bar*

Elbow Size mm	Code	L (mm)	h1 (mm)	h2 (mm)	Box QTY	Item Weight kg	Slip Couplers Required	Primary Couplers Required
90#160	43 348 313	500	351	100	1	9.3	3 x 43 110 317	3 x 43 101 313
110#160	43 348 314	540	351	170	1	10.2	3 x 43 110 317	3 x 43 101 314
160#225	43 348 317	520	433	208	1	16.0	3 x 43 110 320	3 x 43 101 317

* 3 no. additional slip couplers 3 no. additional primary couplers with leads to complete Pipe-in-Pipe tee)



Secondary Contained Reduced Branch Spigot Tee - 10bar*

Elbow Size mm	Code	L (mm)	h1 (mm)	h2 (mm)	Box QTY	Item Weight kg	Slip Couplers Required	Primary Couplers Required
90#160 x 63#110	43 349 313	500	326	85	1	8.6	2 x 43 110 317 1 x 43 110 314	2 x 43 101 313 1 x 43 101 311
110#160 x 63#110	43 349 314	540	326	85	1	9.5	2 x 43 110 317 1 x 43 110 314	2 x 43 101 314 1 x 43 101 311
160#225 x 110#160	43 349 317	520	416	170	1	13.1	2 x 43 110 320 1 x 43 110 317	2 x 43 101 317 1 x 43 101 311

* 3 no. additional slip couplers 3 no. additional primary couplers with leads to complete Pipe-in-Pipe tee

Pipe-in-Pipe

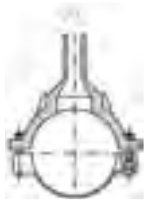

Secondary Contained Interstitial Access Saddle 39.5v - 4bar

Size OD mm	Code	L (mm)	d1 (mm)	d3 (mm)	Box QTY	Item Weight kg
63	43 416 415	100	63	32	20	0.3
90	43 416 417	103	90	32	20	0.7
110	43 416 418	125	110	32	12	0.8
160	43 416 421	131	160	32	8	1.4



Secondary Contained Interstitial Access Saddle with 1/8" Access Port 39.5v - 4bar

Size OD mm	Code	L (min)	d1 (mm)	d3 (min)	Box QTY	Item Weight kg
63 x 3/8" BSP	43 354 415	100	63	32	20	0.3
90 x 3/8" BSP	43 354 417	103	90	32	20	0.7
110 x 3/8" BSP	43 354 418	125	110	32	12	0.8
160 x 3/8" BSP	43 354 421	131	160	32	8	1.4

TRANSITIONS



Secondary Contained Double Spigot Female BSP Transition - 10bar

Size OD mm	Code	L (mm)	d1 (mm)	d2 (mm)	Box QTY	Item Weight kg	Slip Couplers Required	Primary Couplers Required
32#63 x 1 1/2"	43 356 308	138	73	58	5	0.9	1 x 43 110 311	1 x 43 101 308
50#90 x 1 1/2"	43 356 310	157.5	73	58	3	1.1	1 x 43 110 313	1 x 43 101 310
63#110 x 2"	43 356 311	162.5	85	71	2	1.9	1 x 43 110 314	1 x 43 101 311
90#160 x 3"	43 356 313	188.5	99	99	1	6.4	1 x 43 110 317	1 x 43 101 313
110#160 x 4"	43 356 314	208	131	131	1	8.1	1 x 43 110 317	1 x 43 101 314



Secondary Contained PE Stub Flange Assembly Transition - 10bar

Size OD mm	Code	L (mm)	I1 (mm)	I2 (mm)	d1 (mm)	d2 (mm)	d3 (mm)	d4 (mm)	Box QTY	Item Weight kg	Slip Couplers Required	Primary Couplers Required
90#160 x 90 (80NW)	43 997 313	250	161	96	65	160	200	18	1	2.5	1 x 43 110 317	1 x 43 101 313
110#160 x 110 (100NW)	43 997 314	250	173	108	77	180	220	18	1	2.9	1 x 43 110 317	1 x 43 101 314
160#125 x 160 (150NW)	43 997 287	270	203	163	159	234	240	25	285	7.4	1 x 43 110 320	1 x 43 100 317



Secondary Contained Double Spigot Zoning In-Line Anchor - 4bar

Size OD mm	Code	L (mm)	I1 (mm)	I2 (mm)	Box QTY	Item Weight kg	Slip Couplers Required	Primary Couplers Required
32#63	43 496 308	180	70	20	15	0.2	2 x 43 110 311	2 x 43 101 308
50#90	43 496 310	200	90	30	10	0.4	2 x 43 110 313	2 x 43 101 310
63#110	43 496 311	220	100	30	5	0.8	2 x 43 110 314	2 x 43 101 311
90#160	43 496 313	240	100	30	2	1.2	2 x 43 110 317	2 x 43 101 313
110#160	43 496 314	240	100	30	2	1.5	2 x 43 110 317	2 x 43 101 314
160#225	43 496 317	260	220	85	1	4.4	2 x 43 100 320	2 x 43 100 317

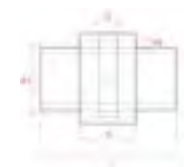

Secondary Contained Double Spigot Support In-Line Anchor with - 4bar

Size OD mm	Code	L (mm)	I1 (mm)	I2 (mm)	d1 (mm)	d2 (mm)	Box QTY	Item Weight kg	Slip Couplers Required	Primary Couplers Required
32#63	43 396 308	180	70	20	41	5	15	0.2	2 x 43 110 311	2 x 43 101 308
50#90	43 396 310	200	90	30	64.5	10	10	0.3	2 x 43 110 313	2 x 43 101 310
63#110	43 396 311	220	100	30	80	10	5	0.7	2 x 43 110 314	2 x 43 101 311
90#160	43 396 313	240	100	30	115.5	10	2	1.1	2 x 43 110 317	2 x 43 101 313
110#160	43 396 314	240	100	30	125.5	10	2	1.4	2 x 43 110 317	2 x 43 101 314
160#225	43 396 317	260	220	85	207.5	10	1	4.3	2 x 43 100 320	2 x 43 101 317

PLX Blue



Features

- High-grade polyethylene material
- Polyethylene black outer skin with sky blue stripes (up to 63#75mm)
- Fusion welded system
- Available in straights and coils
- System fully tested
- Semi-flexible pipework

Benefits

- Safe and durable (30 year design life)
- Resists permeation and anti-clogging properties
- UV resistant
- Fast, simple jointing
- Easy installation and minimal jointing
- System specially suited for Adblue® applications

PLX Blue Single Wall system

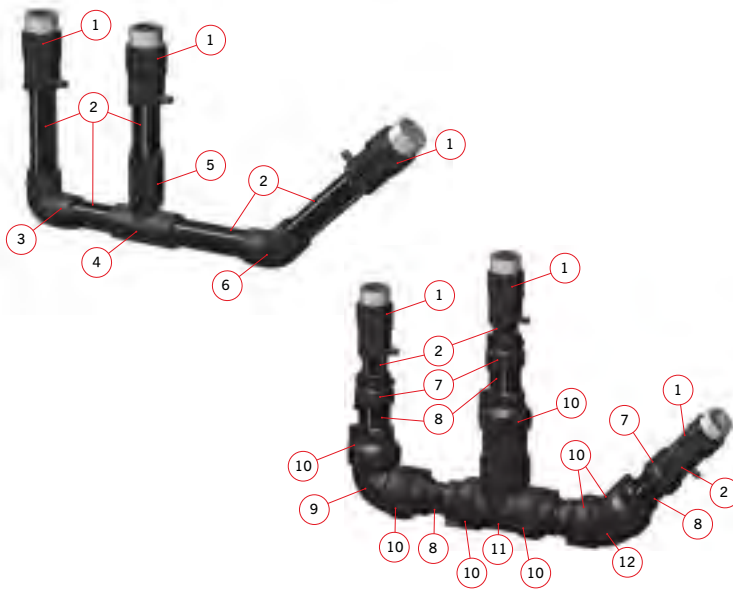

NUMBER	PART CODE	DESCRIPTION
1	34741310	PLX Blue 50 x 1 1/2 inch Female Transition
2	34626310	PLX Blue 50 mm Pipe 6 metre
3	43104310	PLX 50 mm 90 Elbow
4	43408310	PLX 50 mm Equal Tee
5	43100310	PLX 50 mm Coupler
6	43105310	PLX 50 mm 45 Elbow
7	43278444	PLX 50-63 mm Slip Closure
8	34664444	PLX Blue 50-63 mm Pipe 6 metre
9	43248310	PLX 50-90 mm 90 Elbow
10	43278459	PLX 63-90 mm Slip Closure
11	43246310	PLX 50-90 mm E/F Equal Tee
12	43250310	PLX 50-90 mm 45 Elbow

PLX Blue Secondary Contained System

PIPE

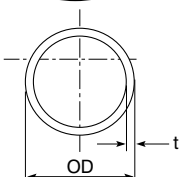

PLX Blue Single Wall Pipe SDR11 Straights - 10bar

Size OD mm	Length m	Code	t (min)	Pack QTY	Pack Size (w) x (h)	Item Weight kg
32	6	34 626 308	3	116	0.6 x 0.55	1.6
50	6	34 626 310	4.6	106	0.65 x 0.6	4.0
63	6	34 626 311	5.8	68	0.7 x 0.67	6.3

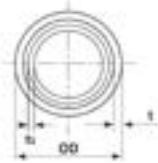
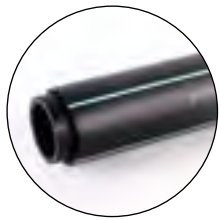

PLX Blue Close-Fit Pipe SDR11#26 Straights - 10bar Primary, 4bar Secondary

Size OD mm	Length m	Code	t (min)	Pack QTY	Pack Size (w) x (h)	Item Weight kg
32#40	6	34 664 413	6.5	50	0.4 x 0.5	3.5
50#63	6	34 664 444	11.1	68	0.7 x 0.67	7.1
63#75	6	34 664 445	11.8	46	0.73 x 0.63	10.5

FITTINGS

PLX Blue Single Wall Fittings

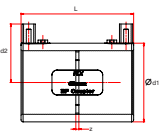

PLX Blue Single Wall Coupler 39.5v - 10bar

Size OD mm	Code	L (mm)	d1 (mm)	d2 (mm)	z (mm)	Box QTY	Item Weight kg
32	43 100 308	83	44	39	2	200	0.1
50	43 100 310	98	65	50	3	110	0.1
63	43 100 311	111	78	58	3	80	0.2

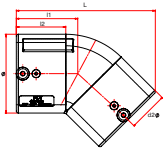

PLX Blue Single Wall 45° Elbow 39.5v - 10bar

Size OD mm	Code	L (mm)	I1 (mm)	I2 (mm)	d1 (mm)	d2 (mm)	Box QTY	Item Weight kg
32	43 105 308	83	48	40	42	38	115	0.1
50	43 105 310	99	57	45	66	50	60	0.2
63	43 105 311	113	65	50	80	57	22	0.2

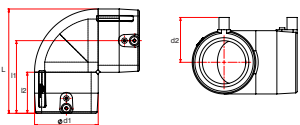

PLX Blue Single Wall 90° Elbow 39.5v - 10bar

Size OD mm	Code	L (mm)	I1 (mm)	I2 (mm)	d1 (mm)	d2 (mm)	Box QTY	Item Weight kg
32	43 104 308	82	60	40	42	38	115	0.1
50	43 104 310	113	80	50	65	49	63	0.2
63	43 104 311	130	91	54	78	56	45	0.4

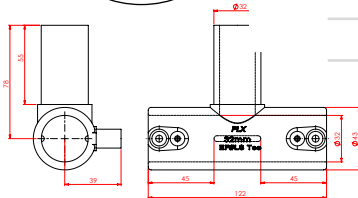

PLX Blue Single Wall Equal Tee (Spigot Branch) 39.5v - 10bar

Size OD mm	Code	L (mm)	l1 (mm)	h (mm)	d1 (mm)	Box QTY	Item Weight kg
32	43 408 308	122	45	78	43	70	0.1
50	43 408 310	133	46	93	65	40	0.2
63	43 408 311	154	51	111	78	24	0.4

PLX Blue Close-Fit Fittings

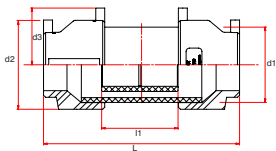

Close-Fit Pipe Joiner 39.5v - 10bar

Size OD mm	Code	L (mm)	l1 (mm)	d1 (mm)	d2 (mm)	Box QTY	Item Weight kg
32#40	43 249 308	201	97	63	83	15	0.5
50#63	43 249 310	250	124	90	98	10	0.8
63#75	43 249 311	285	148	110	130	10	1.2

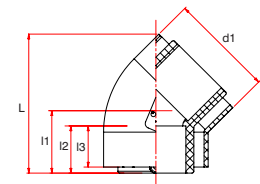

PLX Blue Close-Fit 45° Elbow 39.5v - 10bar*

System Reference Size mm	Elbow Size	Code	L (mm)	l1 (mm)	l2 (mm)	l3 (mm)	d1 (mm)	Box QTY	Item Weight kg	Closures Required
32#40	32#63	43 250 308	84	50	42	40	63	25	0.1	2 x 43 278 430
50#63	50#90	43 250 310	99	58	45	42	90	25	0.3	2 x 43 278 459
63#110	63#110	43 250 311	113	66	50	44	110	20	0.4	2 x 43 278 472

* 2 no. additional closures required to complete Close-Fit elbow

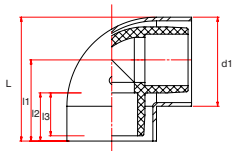

PLX Blue Close-Fit 90° Elbow 39.5v - 10bar

System Reference Size mm	Elbow Size	Code	L (mm)	I1 (mm)	I2 (mm)	I3 (mm)	d1 (mm)	Box QTY	Item Weight kg	Closures Required
32#40	32#63	43 248 308	96	45	40	40	63	25	0.2	2 x 43 278 430
50#63	50#90	43 248 310	128	53	50	42	90	25	0.3	2 x 43 278 459
63#110	63#110	43 248 311	153	100	60	53	110	20	0.9	2 x 43 278 472

* 2 no. additional slip closures required to complete Close-Fit elbow

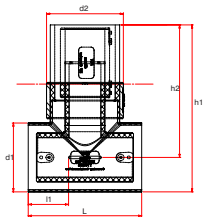

PLX Blue Close-Fit Equal Tee 39.5v - 10bar

System Reference Size mm	Elbow Size	Code	L (mm)	I1 (mm)	h1 (mm)	h2 (mm)	Box QTY	Item Weight kg	Closures Required
32#40	32#63	43 246 308	140	54	70	156.5	10	0.5	3 x 43 278 430
50#63	50#90	43 246 310	160	60	247	202	10	0.9	3 x 43 278 459
63#110	63#110	43 246 311	180	64	266	212	10	1.4	3 x 43 278 472

* 3 no. additional slip closures required to complete Close-Fit elbow

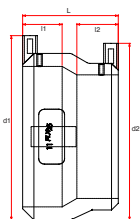

PLX Blue Close-Fit Slip Closure 39.5v - 4bar (for fittings)

Size OD mm	Code	L (mm)	I1 (mm)	I2 (mm)	d1 (mm)	d2 (mm)	Box QTY	Item Weight kg
40#63	43 278 430	78	28	31	99	113	15	0.3
63#90	43 278 459	84	34	34	126	143	15	0.4
75#110	43 278 472	89	34	34	148	148	8	0.5

TRANSITIONS

PLX Blue Transitions

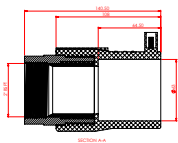

PLX Blue Single Wall EF Female BSP 39.5v - 10bar

Size OD mm	Code	L (mm)	I1 (mm)	I2 (mm)	d1 mm	d2 (mm)	Box QTY	Item Weight kg
32 x 1"	34 394 308	122	83	40.5	44	39	10	0.6
50 x 1½"	34 741 310	139.5	107	63.5	73	53	6	0.7
63 x 2"	34 741 311	140.5	108	64.5	85	59.5	6	0.9

(1 no. closure required to complete PLX Blue Close-Fit transition)

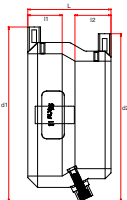

PLX Blue Close-Fit Slip Closure 39.5v - 4bar (for transitions)

Size OD mm	Code	L (mm)	I1 (mm)	I2 (mm)	d1 (mm)	d2 (mm)	Box QTY	Item Weight kg
32#40	43 278 413	69	29	33	74	74	40	0.1
50#63	43 278 444	67	27	29	99	99	30	0.1
63#75	43 278 445	67	27	29	110	113	20	0.2

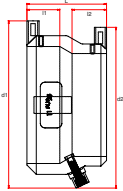
PLX Blue Close-Fit Slip Closure with Test Port 39.5v - 4bar (for transitions)

Size OD mm	Code	L (mm)	l1 (mm)	l2 (mm)	d1 (mm)	d2 (mm)	Box QTY	Item Weight kg
32#40	43 279 413	69	29	33	92	92	40	0.2
50#63	43 279 444	67	27	29	116	116	30	0.3
63#75	43 279 445	67	27	29	129	121	20	0.2

SAFE CONDUCTIVE PIPEWORK FOR FUEL

Durapipe PLX+ is a 'conductive' system, with a complete range of dedicated fusion-welded pipework systems for the safe transfer of fuels. Suitable for use with diesel, bio-diesel and fuel oils.

The Durapipe PLX+ range represents a major innovation in pipework technology as it offers the ultimate in environmental protection with maximum protection against permeation, and leak free joints.

The integral conductive connector ensures that there are no loose items which could go missing during the installation process, whilst the green and yellow striping gives clear indication that the pipe system is 'conductive'.

Key Product Information

- 10 bar pressure rating
- Single wall and secondary containment systems
- 30 year design life
- Size Range: 63mm to 125mm
- Electrofusion system

Key Product Features

- Integral conductive connector
- Green & yellow striping to indicate earthing
- Resists fuel permeation
- Corrosion resistant
- Protects the environment
- Easy to install

Applications

- Suction Systems
- Offset Fill
- Vents
- Tank Chamber Connection
- Sump & Pump Connection

Products

- Single Wall
- Secondary Containment
- Threaded Transitions
- Flanged Transitions

Durapipe



Safe Conductive Pipework for Fuel

Installation Guide

Durapipe PLX+ products are designed to make the installation of fuel lines quicker, easier and more cost-effective than when using traditional materials. The advantages of installing with PLX+ systems are lightness flexibility, durability and totally secure jointing methods.

PLX+ System Presentations, Demonstrations and Technical Support

We offer an unrivalled level of technical support where our experienced team can provide product introductions, jointing demonstrations and installation advice on any given project. They can also provide material take-off advice from architects' drawings.

On-site PLX+ pipe jointing demonstrations can be arranged on request.

Technical Support is available, before, during and after installation.



Trench Excavation

Where pipework has to be laid in trenches, PLX+ pipe systems require minimal excavation. Trench dimensions are normally governed by the pipe diameter and site conditions. In general, they should be as narrow as possible, but typically not less than the outside diameter of the pipe plus 250mm to allow for correct compaction of the side fill.

Minimum depth of cover for PLX+ should be 750mm from ground level to crown of the pipe. It is acceptable to lay pipes directly on the bottom of the trench, provided that the soil is uniform, relatively soft and fine grained and free from large flints, stones and other hard objects, which could damage the pipe wall. The trench bottom should be brought to an even finish to provide consistent support to the pipes along their complete length.

Where pipes are to be laid side by side in wide/open trenches, a minimum cover of 100mm is required and a minimum gap of 100mm should be left between pipes.

100mm thickness of selected bedding material must be placed below the pipe. Gravel or broken stone graded between five and ten millimetres in size will provide suitable bedding since it requires little compaction. Coarse sand is also acceptable provided that the particle size is not less than 3mm but care must be taken to ensure that such backfill cannot migrate as the result of high water tables. Where this possibility prevails, then the trenches must be lined with a geotextile material to prevent the migration.

Pipework must be laid to a gradient of 1:100 back to the tank. Heavy compaction equipment should not be used until the fill over the crown of the pipe is at least 300mm.

Any temporary levelling supports must be removed before the pipework is backfilled to prevent any damage to the pipe resulting from uneven settlement.

Use PLX+ Close-Fit Pipe Coils to reduce the number of joints required for the installation where possible.

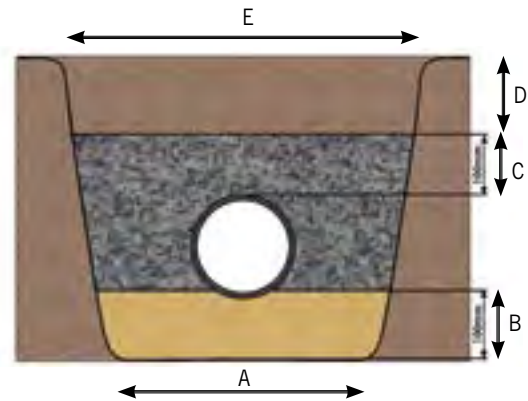

During pipe installation a pipe cross over may be difficult to avoid. Where they occur there must be a filled space between the uppermost pipe and the one beneath. If the pipes are touching this could cause a concentrated load that may result in premature system failure or cause an uneven settlement and liquid to be trapped in system – See PLX+ spacing recommendations at bottom of this page.

Pipe Diameter	A	B	C	D	E
110mm and below	450	100mm minimum	100mm minimum	400mm minimum	lower trench width + 600mm
150mm	450	100mm minimum	100mm minimum	400mm minimum	lower trench width + 600mm
250mm	500	100mm minimum	100mm minimum	400mm minimum	lower trench width + 600mm
315mm	600	100mm minimum	100mm minimum	400mm minimum	lower trench width + 600mm

Shallow and Encased Trenching

Where pipes are to be laid to shallow depths, the pipe must be protected by reinforced concrete to transfer any excessive loadings resulting from the passage of heavy vehicles. In exceptional circumstances, where pipework needs to be totally encased in concrete, the pipework should also be wrapped to prevent differential stresses being applied to the pipe.

Underground Pipe Spacing Recommendations

When installing PLX+ in below ground trenches there is a minimum gap requirement between each pipe being buried. If pipes are installed too close together they are unsupported by the backfill and may buckle and cause the ground to depress. Durapipe recommends the following per diameter of PLX+ pipes..

Pipe Outer Diameter	Gap
50-63mm	50mm
75-110mm	75mm
125mm	125mm



Expansion and Contraction

The thermal expansion of Durapipe PLX+ is 1.5mm/metre/10°C, which is greater than for metal. Allowance must be made for this when designing a PLX+ installation above ground, where significant temperature variation is expected. If the above length change is re-stated as 9mm per 6m pipe length per 10°C of temperature change, the magnitude of potential thermal movement can be better appreciated. The natural flexibility of the pipe, coupled with sensible positioning of the anchor and support brackets, will conveniently accommodate expansion and contraction at changes of direction. In installations where fully end-load bearing joints are used, the compressive or tensile forces set up in the pipeline due to constraint of thermal movement will not detract from long-term performance, but the effects of these forces on pipe support, ancillary equipment and so on, must be considered and allowances made.

The potential for thermal movement is a particular issue where (fully end-load bearing) PLX+ is connected to any non end-load bearing mechanically jointed system. It is essential that such transitions are securely anchored, to negate the risk of any joints in the mechanically jointed system separating.

It is also prudent to allow a newly installed pipeline time to conform to ambient temperature before end connections are made.

Pipe Supports

PLX+ Close-Fit can be installed in below ground formed pipe ducts with the following support guide:

Close-Fit Support Spacing

Pipe Dimensions (mm)	Support Centres
50#63	Continuous
63#75	Continuous

PLX+ Close-Fit pipes can only be installed in below ground applications, either buried, or in a covered duct. If in a covered duct it can be laid on the floor of the duct, or continuously supported using an electrical cable tray or similar. After installation of the pipes a light aggregate or coarse sand is preferred as coverage.

Pipe Bending

The minimum bend radius for Durapipe PLX+ pipes supplied in straight lengths is 25 times the pipe outside diameter. For Secondary Containment systems the outside diameter of the outer pipe must be used as the base calculation. Electrofusion joints should not be subjected to bending stresses until they have fully cooled.

Durapipe PLX+ Earth Bonding Instructions

Where PLX+ ('conductive') pipes are used, there is a requirement to provide earthing and bonding to equalise electrical potential of the underground piping system. Always consult a competent electrical engineer with good knowledge of local and regional rules and regulations.

Key points for effective earth establishment are: Ensure all electrofusion terminal insulating caps are correctly inserted.

All stand alone metal components such as metal backing rings attached with PE stub flanges must be earthed.

Some guidelines are:

NFPA77 – National Fire Protection Association, Recommended Practice on Static Electricity

CENELEC CLC/TR 50404 Electrostatics

Pressure Testing of PLX+ Product Lines Single Wall and Secondary Containment

It is important to remember that site pressure tests are carried out to determine that the installer has fused all electrofusion joints and that all threaded connections have been made.

Pressure testing to prove the suitability of the PLX+ system has already been carried by Durapipe at much higher pressures than would be allowed on site, during the systems design, development and subsequent approval.

Further stringent test regimes have also been performed by the many Independent Test Bodies who have certified that PLX+ is suitable for use as an underground pipework system for conveying liquid fuels.

Health and Safety

- Compressed air may be used to test new pipework systems.
- Nitrogen, which is an inert gas, must always be used to test existing lines where vapours or liquid fuels may still be present. The nitrogen gas will also serve to purge the pipework of any vapours and air. Site Management must always be informed when a pressure test is due to be carried out using compressed gases at these higher pressures to ensure the safety of other site personnel.
- Compressed gases occupy 3 times the volume of a given space (when compared to water) to give the equivalent pressure. Separation of any item within the system would have an explosive effect due to the sudden release of this stored energy.
- The maximum pressure of 4bar for primary (product line) and 2bar for secondary containment should never be exceeded because of these safety concerns.

Pressure Test Guidelines

- All pressure testing equipment should be subject to manufacturers calibration requirements before use.
- All tank connections above ground or below ground should be disconnected or isolated.
- For accurate consistency of the pressure measurement it is recommended that the target pressure should be a minimum of 50% of the gauge scaling ie. a test pressure of 4bar (60psi) the gauge range to be 0 to 8bar (0 to 120psi).
- It is recommended that a suitable pressure relief valve be incorporated into the system to prevent overcharging of the pipe. This should be set at no more than 0.5bar (10psi) above the target pressure.
- When pressure testing the primary pipe, the secondary containment pipe must be open to atmosphere, this is also applicable for testing of the secondary leaving the primary pipe open to atmosphere.
- The use of compressed air is suitable as a medium for pressure testing all new pipework installations.
- The use of Nitrogen (from a pressure cylinder) for pressure testing of the pipe system should be applied when the pipe system has been used:
 - for pressure testing existing lines under planned maintenance procedures.
 - or, if a fuel has been used to ballast a storage tank.

Pressure Testing Procedure for Primary (product) Lines

Test heads are fixed to transition fittings (at the dispenser) to allow pressure to be introduced and for the internal pressure to be measured. The other end (at the tank) must be closed off using spade connections between the compact flange/ flange connections to ensure that the tank is both isolated and that the pressure test is not also being applied to the tank.

- Introduce air/nitrogen to an initial pressure of 0.5bar (10psi).
- Examine all the electrofusion joints and threaded joints for any leakage using soap solution (where possible).
- The pressure may then be raised in 0.5bar increments over 15 minute intervals to a maximum pressure of 4.0bar (60psi).
- Once the target pressure is reached, measurements should be taken from the pressure gauge:
 - The minimum duration of test should be 1 hour.

NB: Polyethylene pipe is subject to creep under pressure and temperature. It may be necessary to apply a 'top up' to the pressure in the system after a few minutes to allow for these material fluctuations under ambient temperatures. Consideration must be made for higher temperature factors.

Pressure Testing Procedure for Secondary Containment Lines

Electrofusion Type Closures

Durapipe has designed and developed Electrofusion Short Pattern closure/ Stepped coupler fittings to fuse the outer containment pipe/fittings to the outside of the PLX+ product line pipes.

These fittings are designed to seal the interstice by electrofusion, and where fitted with access ports, permit connection to monitoring equipment using all the different mediums.

- Introduce air to an initial pressure of 0.5bar (10psi).
- Examine all the electrofusion joints and threaded joints for any leakage using soap solution (where possible).
- The pressure may then be raised in 0.5bar increments over 15 minute intervals to a maximum pressure of 2.0bar (30psi).
- Once the target pressure is reached, measurements should be taken from the pressure gauge:
 - The minimum duration of test should be 1 hour.

NB: Polyethylene pipe is subject to creep under pressure and temperature. It may be necessary to apply a 'top up' to the pressure in the system after a few minutes to allow for these material fluctuations under ambient temperatures. Consideration must be made for higher temperature factors.

Note:

The PLX+ Electrofusion Closure Fittings and the access ports are designed to allow the interstice to be monitored using over pressurization methods up to a maximum continuous working pressure of 4bar (60psi).

These fittings have been designed for use as secondary containment closure fittings only and are marked as such. They must NEVER be used to connect PLX+ product lines (Suction/Pressure) or PLX+ Fill & Vent lines.

Durapipe PLX+ Electrofusion and Spigot Fittings

The PLX+ system comprises of a wide range of Single Wall and Secondary Contained Spigot and Electrofusion fittings - couplers, elbows, tees and closures. The jointing of PLX+ pipes through electrofusion offers a permanent, rapid and convenient method of pipe joining.

This advanced innovative manufacturing technique of all fittings ensures:

- Deep electrofusion sockets for maximum joint strength on primary pipes
- Gap filling fusion joint process
- 39.5V Operation
- The heating coils are placed as close to the joint surfaces as possible
- Wire position accurately controlled during manufacture and the fusion process
- Uniform heat distribution during the electrofusion process
- Melt pressure and temperature are both accurately controlled
- Heating coils are protected from damage during installation
- Barcoded containing size and fusion and cooling times
- Fusion indicators
- Mushroom caps - used after the cooling process for insulating the fusion terminals

Electrofusion Principles

Hot and cold zones, sometimes called melt and freeze zones, are formed after energising the coil. The cold zones ensure that molten material is locked in place and that a melt pressure is created and controlled throughout the jointing process. The precisely controlled pitch and positioning of the heating coil in relation to the inner surface of the socket ensures uniform heat distribution.

PLX+ electrofusion fittings are designed for use with 39.5 volt output Electrofusion Control Units.

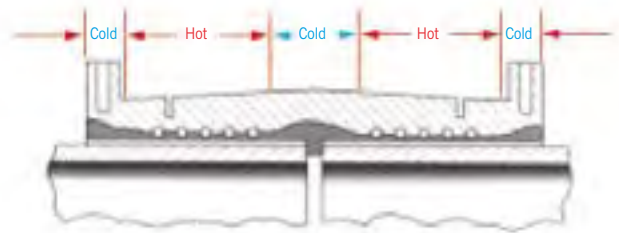

The Fusion sequence

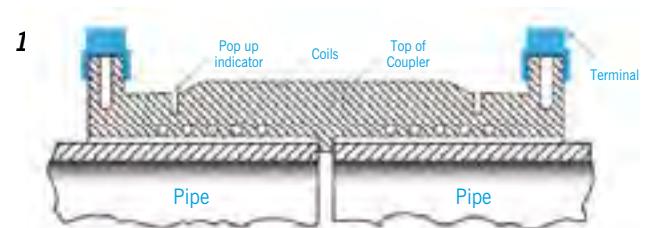

Pipe positioned in coupler prior to energising coil.

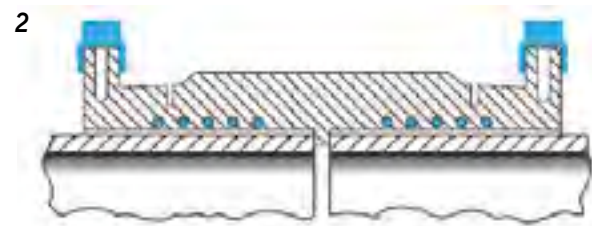

Coil energised.

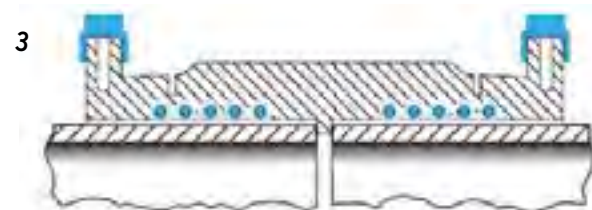

All PLX+ electrofusion fittings employ the same basic principle. The socket of the fitting incorporates an electrical heating coil. An electrofusion control unit (ECU) regulates and supplies the power necessary to energise and heat the coil. When the coil is energised the immediate pipe and fitting surfaces melt to form an expanding pressurised pool of molten material. The continued introduction of heat energy causes the expanding pool of molten material to mix under the melt pressure, forming a homogenous mass that is vital in producing a good weld. Following the termination of the heat cycle, the fitting and pipe are left to cool allowing the melted material to solidify to form a joint that is stronger than the pipe.

Using PLX+ EF fittings, consistent, reproducible, high integrity joints will be achieved if:

- Pipe and fittings preparation instructions are followed (see page 12)
- Pipe and fittings assembly instructions are followed (see page 16)

This will ensure that the installed PLX+ systems are wholly secure with leak tight joints.

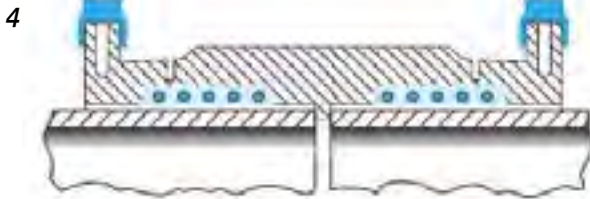

Area of melt extends leading to expansion towards pipe surface.

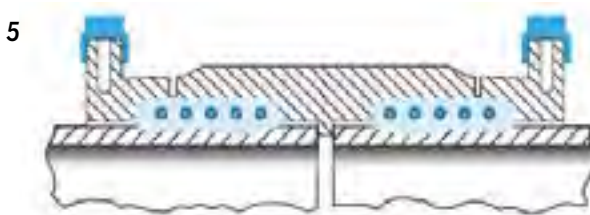

Heat transfers to pipe wall and pipe material starts to melt.



Melt solidifies at the start of the cold zones, thereby sealing the melt zone. Further input of energy causes increase in melt pressure.

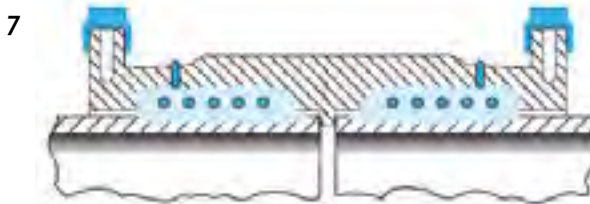

Melt pressure reaches optimum value at end of energising cycle. Emergence of the melt at the indicator holes shows that fusion is complete.

The height of the weld indicators, post-weld is not directly related to the quality of the joint formed.

IT IS IMPERATIVE THAT MUSHROOM CAPS ARE FITTED ONTO BOTH TERMINALS AFTER WELDING PROCESS HAS BEEN COMPLETED.

PLX+ Barcode Introduction

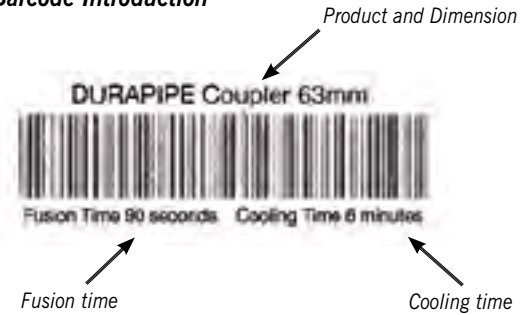

Electrofusion Control Units (ECUs) can be supplied with the ability to read a barcode where fixed to an electrofusion fitting. These machines have a 'scanner' attached, which the operator uses to input the data by scanning the barcode. Barcode or automatic control units also have data logging facilities that provide traceability of site welding parameters. An output socket on the ECU allows downloading of this information onto a computer database or printer to give a complete Quality Check (QC) record of the joints which have been made. This information can be downloaded daily, or upon completion of the project. The units will then store the operations. The ECU barcode will display a description of the fitting, which includes three digits to denote size, and this should be read and checked by the operator before proceeding.

Temperature/Fusion Time Compensation

Durapipe PLX+ electrofusion fittings are designed to work on a fixed fusion time in ambient temperatures between -5°C and +23°C. For further details on fusion time compensation please contact Durapipe Technical Support.



PLX+ Introduction

Static Electricity

Key points for effective earth establishment are:

- Ensure that all electrofusion terminal insulating (mushroom) caps are correctly inserted in the weld terminals.
- All stand-alone metal components such as metal backing rings attached with PE stub flanges must be earthed.

Some guidelines to consider are:

NFPA77 – National Fire Protection Association, Recommended

Practice on Static Electricity

CENELEC CLC/TR 50404 Electrostatics

The installation of PLX+ pipework is almost identical to the installation of PLX standard pipework. All installation tools required to install PLX+ and PLX are standard. In addition you will require a PLX+ conductivity tester kit.

Using the Conductivity Tester

Calibration of the PLX+ conductivity tester unit should be made periodically, for example, at the start of every installation. In order to calibrate, the following test sequence should be applied



1. Connect the cables to the tester unit and to the ends of the pipe run (as shown below). The tester unit comes with 100m of cable, if the pipe run is longer than this, the system will need to be tested in shorter sections of up to 100m.
2. Press the "TEST" button. A green LED and a beep indicate that electrical continuity is good. A red LED and no beep indicate that electrical continuity is insufficient.

Always allow for the welded fittings to cool, prior to testing the completed run.

When testing the completed pipe run, please ensure that the pipework is not earthed.

Test the conductivity of the pipe start point to the end point, as per image below.



Connect the Piping System to Earth and Provide Earth Bonding

The conductive piping system must be connected to earth. Bonding and earthing of adjacent conductive objects is necessary only if it is required by applicable regulations and legislation.

Always consult a competent electrical engineer with good knowledge of local and regional rules and regulations to facilitate the testing.

Re-Testing or Recurring Testing

PLX+ pipework does not need to be tested for electrical continuity at periodic intervals, due to the conductive properties remaining stable and plastic connections remaining non-corrodible during the life of the installation.

However, should recurrent testing be required due to local regulations, always consult a competent electrical engineer with good knowledge of local and regional rules and regulations to facilitate the testing.

Pipe marking

For easy identification, PLX+ Single Wall pipe has 4 x green & yellow dual striping, whilst PLX+ Close-Fit has 4 x green and 4 x yellow equally and alternately spaced stripes.

Since PLX+ is clearly identified by this green and yellow striping, no additional markings or straps are required.

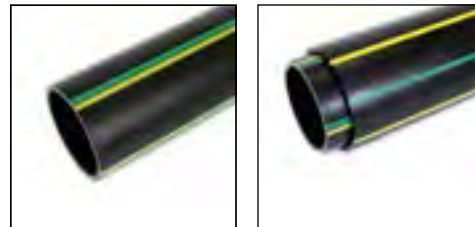

Standards and Approvals

Durapipe UK high performance plastic pipework systems are lightweight and easy to install whilst having excellent corrosion and limescale resistance properties.

Durapipe UK products are manufactured to the highest level and meet the requirements of many international standards and approvals.

Furthermore, our products are manufactured in an environment that complies with the requirements of ISO 9001 and ISO 14001.

PLX+ is manufactured in accordance with both IECTS 60079-32-1 & EN13463-1 electrical safety certifications, and complies with ATEX 137 workplace directive 1999/92/EC..

Maintenance Note

When the battery indicator LED turns red, replace the 9V battery.

Pipe Preparation Instructions

The Durapipe PLX+ range comprises of two systems, Single Wall and Secondary Contained Close-Fit. As these systems are different there are differences in pipe preparation.

You will need:

- PLX Pipe cutter + deburring tool
- PLX Pipe preparation kit or PLX+ hand scraper
- PLX Isopropanol Wipes
- Tape measure
- Pipe marking utensil
- Pipe protection sleeve (Close-Fit only)
- PLX+ Conductivity Tester Kit

All Single Wall – Primary Pipe Preparation

- 1a.** It is important to make sure the pipe is cut clean and square, a wheel cutter is best for this job. The use of a cutter ensures a square swarf-free pipe end preparation.
- 1b.** Deburr the inside of the pipe with an appropriate deburring tool.



- 2.** Wipe loose dirt from pipe ends.



- 3.** Measure the fitting from the centre to the end using a tape measure. Mark the pipe, using a utensil, around the circumference, with the recorded measurement.



- 4.** Using the PLX+ pipe preparation kit select the correct size mandrel to fit the pipe being prepared. Rotate the mandrel shaft anti-clockwise so that the mandrel expands and firmly grips the inside of the pipe. Using the spanner tighten the mandrel with 1/4 turn.



- Place the preparation tool onto the shaft and slide along by depressing the release button to disengage the drive until the cutter tip is aligned with the marked socket depth. Position the cutter tip approximately 1mm above the pipe surface.

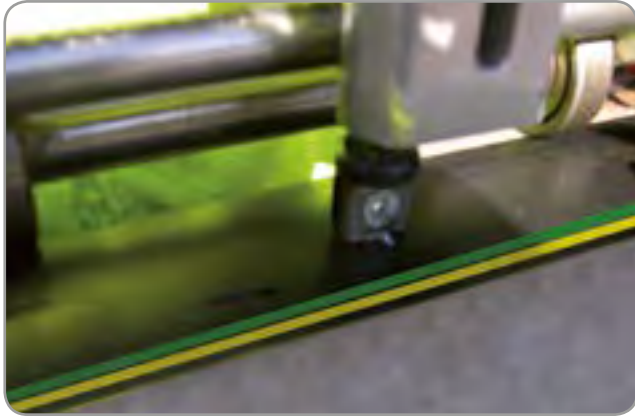

- Apply the spring tension to the cutter tip. Then rotate the tool clockwise until the cutter has moved over the length of pipe to be prepared. A continuous ribbon of PE material should have been removed.



- Durapipe PLX+ Isopropanol wipes are available to wipe the pipe surface should they become contaminated.



- Mark the pipe again using a utensil and a tape measure or the PLX+ pipe fitting.



- You can begin the electrofusion process.

Close-Fit – Pipe Preparation

1. It is important to make sure the pipe is cut clean and square, a wheel cutter is best for this job. The use of a cutter ensures a square swarf-free pipe end preparation.



2. Wipe loose dirt from pipe ends. Mark the outer pipe to approximately 150mm from the edge, using a tape measure and pipe marking utensil.



3. Manually prepare the surface of the outer pipe using a scraper, from the mark up to the end of the pipe.



4. Measure the primary fitting from the centre to the end, marking this dimension + an additional 10-15mm on the surface of the outer pipe using the marking utensil.



5. Place the PLX+ Pipe protection sleeve between the primary and secondary pipe.



6. Cut the pipe square using a PLX+ pipe cutter. The use of a cutter ensures a square swarf-free pipe end preparation.



7. Safely remove the PLX+ Pipe protection sleeve together with the unwanted secondary pipe.



8. Mark the pipe again using a utensil and a tape measure or the PLX+ pipe fitting.
9. Now proceed to follow Primary Pipe Preparation guidelines steps 1-9.

Single Wall Jointing Guide

1. Remove fitting from packaging. Place the pin mushroom caps close to where you are performing jointing. It is imperative that these caps are fitted post-weld.



2. Carefully wipe the inner bore of the fitting (in between the inner bore and the integral conductive connector) with an isopropanol wipe ensuring it is clean only if necessary.



For information on static electricity please refer to Page 68.

3. Fully insert the fitting onto the pipe. Ensure the correct insertion and mark the position relative to the pipe.



4. Repeat for the opposite socket and place pipe onto PLX+ Pipe Clamp for stability.



5. Connect the leads from the electrofusion control unit to the terminals on the fitting. The lead connectors can be attached to either terminal.



6. Note the fusion time on the fitting barcode.



7. Enter the fusion time. Press the green or enter button to proceed. Durapipe offers both manual and barcode reading Electrofusion control units. The barcode reading units have a light pen, which the operator uses to input the necessary data.



8. At the end of the fusion cycle the indicator pins will have risen. Remove the electrofusion control unit leads.



9. After the cooling time is shown on the fitting barcode, insert the pin mushroom caps to prevent an accidental repeat of the fusion process and to insulate the weld pins.



Secondary Containment Fittings

The PLX+ Secondary Containment System has a number of specific secondary containment fittings designed to ensure the primary system is independent to the secondary ensuring a complete leak tight system.

The PLX+ Secondary Containment Fittings range are manufactured and fabricated with the terminal shroud of the fitting reduced to fit inside the secondary spigot fitting. A flying lead is fitted to each terminal to provide connection to the electrofusion unit.

Before fusion begins, ensure that the surface of the secondary spigot fitting has been prepared using a PLX Hand Scraper.

PLX+ Terminal Adaptors (43EW0004) are designed to connect the flying leads of the fitting to the electrofusion control unit connection leads.

The outer sleeving of the flying leads is pre-cut, but left in place to protect the wire ends from fraying. Remove this outer sleeve by twisting, inserting the 'bared' wire into the hole provided in the PLX+ Terminal Adaptor. The PLX+ Adaptor is spring loaded and requires the plunger to be squeezed in order to expose the holes and allow for the wire insertion. When released the wire will be firmly held in position. The brass end then becomes the pin for connecting to the Electrofusion Control Unit.

After fusion and cooling periods have elapsed, remove the PLX+ Terminal Adaptors. As fusion is now complete, the flying leads may be cut, as they serve no further purpose.



Close-Fit Secondary Containment Jointing Guide

For information on static electricity please refer to Page 68.

It is important before you begin to follow the Pipe Preparation Guide in the previous chapter. For all Close-Fit Secondary Containment Jointing PLX+ Closures must be used at either side of the fitting.

1. Remove fittings from packaging
2. Place pin mushroom caps close to where you are performing jointing. It is imperative that these caps are fitted post-weld.
3. Wipe the inner bore of the fitting (in between the inner bore and the integral conductive connector) with an isopropanol wipe ensuring it is clean, only if necessary.
4. Mark the socket entry depths on all the pipes.
5. Ensure that all spigot fittings are manually scraped revealing a virgin layer of PE for welding.



6. Fully insert the fittings onto the pipes, ensuring the PLX+ Closure Fittings are positioned on the secondary pipe, either side of the fitting. Ensure correct insertion to the marked positions for both sockets.



7. Attach the PLX+ terminal adaptors (43EW0004) as per guidelines below.



8. Connect the leads from the electrofusion control unit to the PLX+ terminal adaptors. The lead connectors can be attached to either terminal.



9. Note the fusion time on the fitting barcode.



10. Enter the fusion time. Press the green or enter button to proceed. Durapipe offers both manual and barcode reading Electrofusion Control Units. The barcode reading units have a light pen, which the operator uses to input the necessary data.



11. Remove the PLX+ Terminal Adaptors.

12. The flying leads may be cut as they serve no further purpose.



13. Position the secondary PLX+ Closures onto each side of the spigot fitting.



14. Connect the leads from the Electrofusion Control Unit to the secondary closures.



15. Enter the fusion time. Press the green or enter button to proceed. Durapipe offers both manual and barcode reading Electrofusion Control Units. The barcode reading units have a light pen, which the operator uses to input the necessary data.



16. At the end of the fusion cycle the indicators will have risen.
17. After allowance of the cooling time as shown on the fitting, insert the mushroom caps to prevent an accidental repeat of the fusion process and also to insulate the terminals.



PLX+ Jointing Demonstrations Available



Contact the Durapipe Technical Support Team:

technical@durapipe.co.uk

01543 471681

PLX+ Pipework Systems



Features

- Polyethylene composite material
- Single wall & dual containment
- Protective barrier co-extruded layer
- Conductive co-extruded bore layer
- Integral conductive connector
- Polyethylene black outer skin with green & yellow stripes
- Fusion welded system
- Available in straights and coils
- EN 14125 fully accredited
- Complies with ATEX 137 directive
- Semi-flexible pipework
- 360° secondary contained system

Benefits

- Safe and durable (30 year design life)
- Resists permeation and anti-clogging properties
- UV resistant
- Fast, simple jointing
- No need for additional separate conductive connector
- Easy installation and minimal jointing
- Striping ensures pipe is easily identifiable as 'conductive'

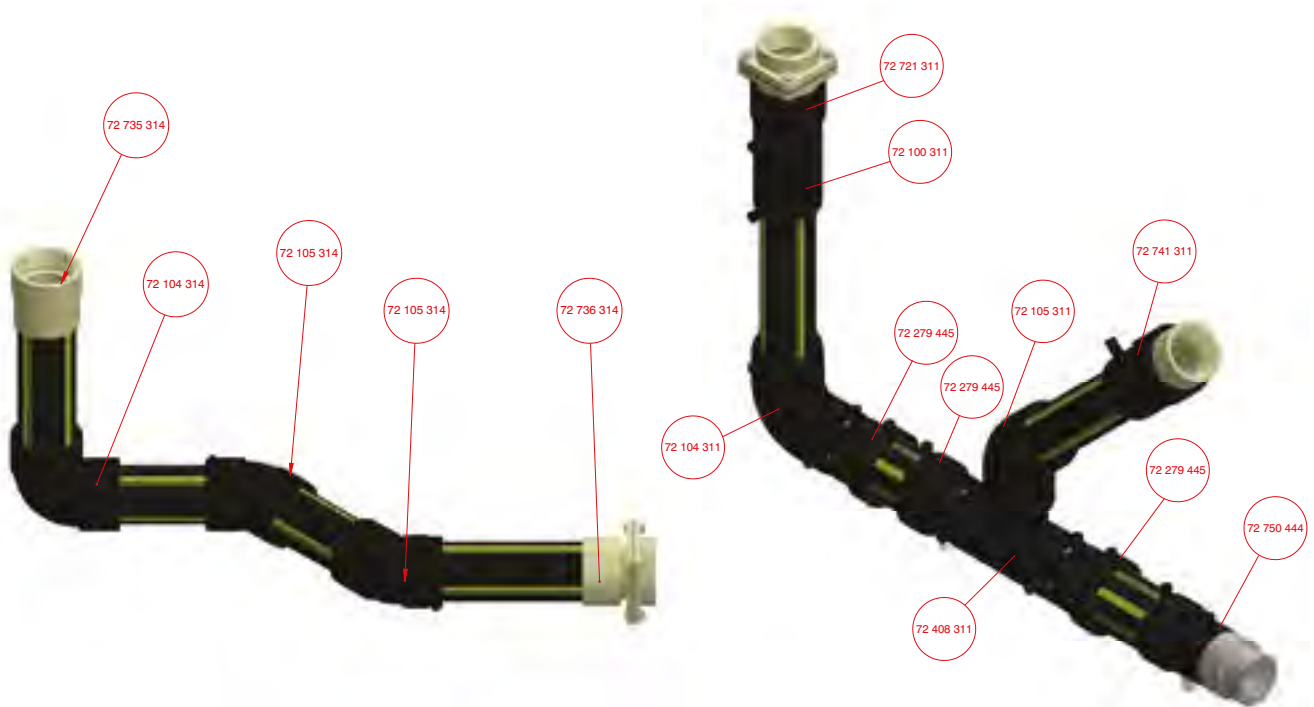

PIPE

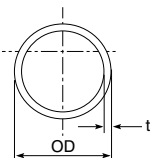
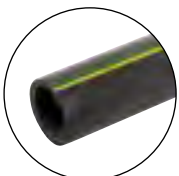

Single Wall Pipe SDR11 Straights - 10bar

Size OD mm	Length m	Code	t (min)	Pack QTY	Pack Size (w) x (h)	Item Weight kg
63	6	72 626 311	5.8	68	68	6.3

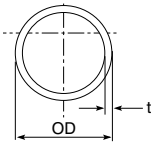
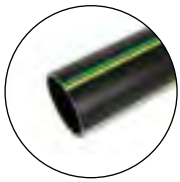

Single Wall Pipe SDR11 Coils - 10bar

Size OD mm	Length m	Code	t (min)	Coil QTY	Pack Size (w) x (h)	Item Weight kg
63	50	72 614 311	5.8	1	1.7 x 0.26	52.6
63	100	72 615 311	5.8	1	1.95 x 0.37	105.2

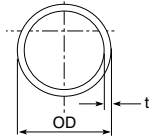
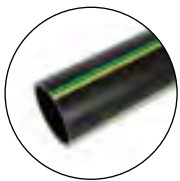

Single Wall Gravity Fill & Vent Pipe SDR17 - 4bar

Size OD mm	Length m	Code	t (min)	Pack QTY	Pack Size (w) x (h)	Item Weight kg
90	6	72 609 313	5.3	34	0.74 x 0.64	8.3
110	6	72 609 314	6.5	23	0.75 x 0.65	13.1

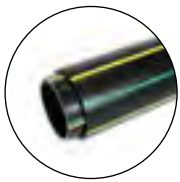

Close-Fit Pipe SDR11#26 Straights - 10bar Primary, 4bar Secondary

Size OD mm	Length m	Code	t (min)	t1 (min)	Pack QTY	Pack Size (w) x (h)	Item Weight kg
63#75	6	72 664 445	2.9	5.8	46	0.73 x 0.63	10.5

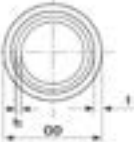
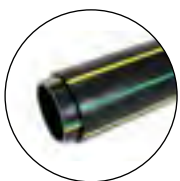

Close-Fit Pipe SDR11#26 Coils - 10bar Primary, 4bar Secondary

Size OD mm	Length m	Code	t (min)	t1 (min)	Coil Size (w) x (h)	Item Weight kg
63#75	50	72 624 445	2.9	5.8	1.7 x 0.4	87.6
63#75	100	72 649 445	2.9	5.8	2.1 x 0.42	175.0

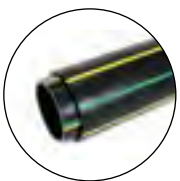

Close-Fit Gravity Fill & Vent Pipe SDR17#26 Straights - 4bar

Size OD mm	Length m	Code	t (min)	t1 (min)	Pack QTY	Pack Size (w) x (h)	Item Weight kg
90#110	6	72 665 446	4.2	5.3	23	0.75 x 0.65	15.1
110#125	6	72 665 447	4.8	6.5	18	0.73 x 0.7	24.6

SINGLE WALL FITTINGS

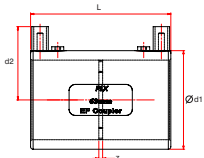

Single Wall Coupler 39.5v - 10bar*

Size OD mm	Code	L (mm)	d1 (mm)	d2 (mm)	z (mm)	Box QTY	Item Weight kg
63	72 100 311	111	78	58	3	80	0.2
90	72 100 313A	127	119	74	3	36	0.5
110	72 100 314A	135	141.5	82	3	22	0.7

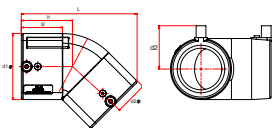

Single Wall 45° Elbow 39.5v - 10bar*

Size OD mm	Code	L (mm)	I1 (mm)	I2 (mm)	d1 (mm)	d2 (mm)	Box QTY	Item Weight kg
63	72 105 311	113	65	50	80	57	22	0.2
90	72 105 313A	154	89	69	115	75	18	0.7
110	72 105 314A	172	99	70	136	85	9	1.0

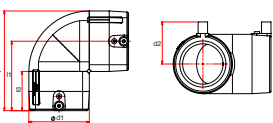

Single Wall 90° Elbow 39.5v - 10bar*

Size OD mm	Code	L (mm)	I1 (mm)	I2 (mm)	d1 (mm)	d2 (mm)	Box QTY	Item Weight kg
63	72 104 311	130	91	54	78	56	45	0.4
90	72 104 313A	181	126	69	111	72	20	0.9
110	72 104 314A	210	142	71	136	85	9	1.3

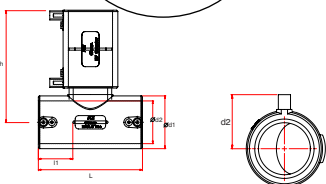

Single Wall Equal Tee 39.5v - 10bar*

Size OD mm	Code	L (mm)	I1 (mm)	I2 (mm)	d1 (mm)	d2 (mm)	Box QTY	Item Weight kg
63	72 410 311	154	51	111	78	56	24	0.4

* Please note that although the fitting is 10bar rated, when used in conjunction with a SDR17 4bar pipe this will result in a 4bar system.

SECONDARY CONTAINED FITTINGS

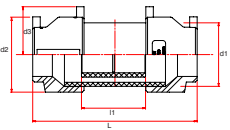

Close-Fit Pipe Joiner 39.5v - 10bar*

Size OD mm	Code	L (mm)	I1 (mm)	d1 (mm)	d2 (mm)	d3 (mm)	Box QTY	Item Weight Kg
63#75	72 249 311	285	175	110	130	83	10	1.2
90#110	72 249 313A	304	147	160	204	109	3	3.8
110#125	72 249 314A	286	155	160	204	109	5	3.8

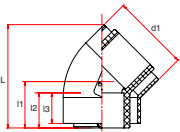

Secondary Contained 45° Elbow 39.5v - 10bar* (2 no. additional closures required to complete Close-Fit elbow)

System Ref Size mm	Elbow Size mm	Code	L (mm)	I1 (mm)	I2 (mm)	I3 (mm)	d1 (mm)	Box QTY	Item Weight kg	Closures Required
63#110	63#110	72 250 311	113	66	50	44	110	20	0.4	2 x 43 278 472
90#110	90#160	72 262 313A	240	108	86	69	160	6	1.4	2 x 43 278 475
110#125	110#160	72 262 314A	240	108	82	70	160	6	1.7	2 x 43 278 476

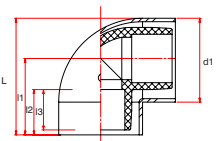

Secondary Contained 90° Elbow 39.5v - 10bar* (2 no. additional slip closures required to complete Close-Fit elbow)

System Ref Size mm	Elbow Size mm	Code	L (mm)	I1 (mm)	I2 (mm)	I3 (mm)	d1 (mm)	Box QTY	Item Weight kg	Closures Required
63#110	63#110	72 248 311	153	100	60	53	110	20	0.9	2 x 43 278 472
90#110	90#160	72 263 313A	235	155	103	69	160	5	1.8	2 x 43 278 475
110#125	110#160	72 263 314A	235	135	93	71	160	5	2.1	2 x 43 278 476

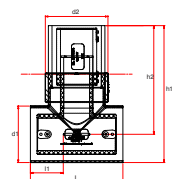

Secondary Contained Tee 39.5v - 10bar* (3 no. additional slip closures required to complete Close-Fit tee)

System Size mm	Tee Size mm	Code	L (mm)	I1 (mm)	I2 (mm)	h1 (mm)	h2 (mm)	d1 (mm)	Box QTY	Item Weight kg	Closures Required
63#110	63#110	72 246 311	180	64	266	212	110	122	10	1.4	3 x 43 278 472

* Please note that although the fitting is 10bar rated, when used in conjunction with a SDR17 4bar pipe this will result in a 4bar system.

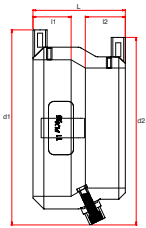
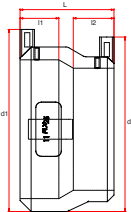

Secondary Contained Slip Closure 39.5v - 4bar

Size OD mm	Code	L (mm)	I1 (mm)	I2 (mm)	d1 (mm)	d2 (mm)	Box QTY	Item Weight kg
63#75	43 278 445	67	27	29	110	113	20	0.2
75#110	43 278 472	89	34	34	148	130	20	0.3
90#110	43 278 473	87	35	34	148	138	10	0.3
110#125	43 278 474	85	35	37	165	158	10	0.3
110#160	43 278 475	113	34	35	204	179	6	0.7
125#160	43 278 476	100	34	35	204	188	8	0.6

Secondary Contained Slip Closure with 1/8" BSP Access Port 39.5v - 4bar

Size OD mm	Code	L (mm)	I1 (mm)	I2 (mm)	d1 (mm)	d2 (mm)	Box QTY	Item Weight kg
63#75	43 279 445	67	27	29	127	121	20	0.1
75#110	43 279 472	89	34	34	165	148	8	0.5
90#110	43 279 473	87	35	34	162	152	10	0.4
110#125	43 279 474	85	35	37	180	173	10	0.5
110#160	43 279 475	113	34	35	204	179	5	0.8
125#160	43 279 476	100	34	35	209	193	7	0.8

SINGLE WALL TRANSITIONS

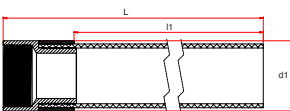

Single Wall Long Spigot Female Extended BSP - 10bar

Size OD mm	Code	L (mm)	I1 (mm)	d1 (mm)	Box QTY	Item Weight kg
63 x 2"	72 481 311	838	760	85	20	4.0

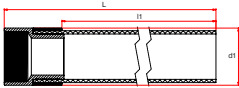

Single Wall Long Spigot Female Extended BSP Fill & Vent - 4bar

Size OD mm	Code	L (mm)	I1 (mm)	d1 (mm)	Box QTY	Item Weight kg
90 x 3"	72 735 313A	800	700	99	20	6.0
110 x 4"	72 735 314A	803	680	131	20	7.5

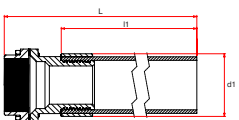

**Single Wall Long Spigot Female Compact Flange Extended BSP - 4bar
(also Fill & Vent)**

Size OD mm	Code	L (mm)	I1 (mm)	d1 (mm)	Box QTY	Item Weight kg
63 x 2"	72 482 311	854	755	83	20	4.0
90 x 3"	72 736 313A	841	700	115	20	6.5
110 x 4"	72 736 314A	816	680	145	20	8.0

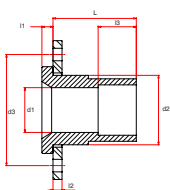

Single Wall Stub Flange - 10bar

Size OD mm	Code	L (mm)	I1 (mm)	I2 (mm)	I3 (mm)	d1 (mm)	d2 (mm)	d3 (mm)	Box QTY	Item Weight kg
63 (50NW)	72 271 311	115	10	8	55	44	74	125	50	1.6
90 (80NW)	72 271 313A	136	17	13	79	138	107	160	10	2.3
110 (100NW)	72 271 314A	136	18	9	82	158	127	180	5	2.8

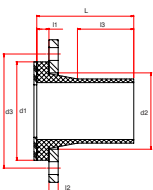

Single Wall PE Stub Flange Assembly - 4bar (Various SDR)

Size OD mm	Code	SDR	L (mm)	I1 (mm)	I2 (mm)	I3 (mm)	d1 (mm)	d3 (mm)	Box QTY	Item Weight kg
63 (50NW)	72 329 311	11	117	14	8	63	102	125	10	1.7
90 (80NW)	72 328 313A	17	136	17	8	79	138	160	7	2.3
110 (100NW)	72 328 314A	17	136	18	8	82	158	180	5	2.8

SECONDARY CONTAINED TRANSITIONS



Close-Fit EF Female BSP 39.5v - 10bar

Size OD mm	Code	L (mm)	I1 (mm)	I2 (mm)	I3 (mm)	d1 (mm)	d2 (mm)	d3 (mm)	Box QTY	Item Weight kg
63#75 x 2"	72 749 445	151	27	99	30	116	59	65	6	6.0

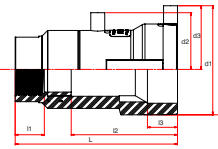

Close-Fit EF Female BSP with Test Port 39.5v - 10bar

Size OD mm	Code	L (mm)	I1 (mm)	I2 (mm)	I3 (mm)	d1 (mm)	d2 (mm)	d3 (mm)	Box QTY	Item Weight kg
63#75 x 2"	72 750 445	151	27	99	30	123	59	65	6	6.0

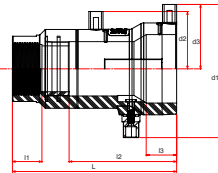

Single Wall Spigot Female Extended BSP Fill & Vent - 4bar

Size OD mm	Code	L (mm)	I1 (mm)	d1 (mm)	Box QTY	Item Weight kg
90 x 3"	72 735 313A	800	700	99	20	6.0
110 x 4"	72 735 314A	803	680	131	20	7.5

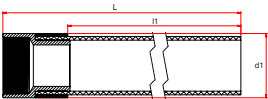

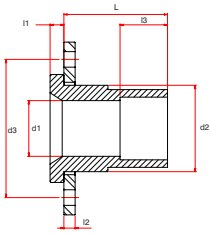
Single Wall SDR11 Stub Flange - 10bar

Size OD mm	Code	L (mm)	I1 (mm)	I2 (mm)	I3 (mm)	d1 (mm)	d2 (mm)	d3 (mm)	Box QTY	Item Weight kg
63 (50NW)	72 271 311	115	10	8	55	44	74	125	50	1.6

Single Wall SDR17 Stub Flange Fill & Vent - 4bar

Size OD mm	Code	L (mm)	I1 (mm)	I2 (mm)	I3 (mm)	d1 (mm)	d2 (mm)	d3 (mm)	Box QTY	Item Weight kg
90 (80NW)	72 271 313A	136	17	13	79	138	107	160	10	2.3
110 (100NW)	72 271 314A	136	18	9	82	158	127	180	5	2.8

PLX Accessories



Features

- New and improved dedicated range of welding machines
- Close-Fit pipe tools range
- Flying lead adaptors
- New and improved dedicated range of clamps

Benefits

- Ensuring traceable welding records & ease of installation
- Primary pipe protection
- Ease of installation for secondary contained systems
- Improved installation times

ACCESSORY FITTINGS



PLX Duraseal - Threaded

Size OD mm	Code	L (mm)	d1 (mm)	Box QTY	Item Weight kg
50	43 270 310	69	119	25	0.4
50#63	43 270 444	121	198	20	0.5
63	43 270 311	95	198	20	0.7
63#75	43 270 445	121	198	15	0.8
75	43 270 312	95	198	15	0.5
90	43 270 313	95	198	10	0.7
110	43 270 314	95	198	10	0.7

WELDING MACHINES & ACCESSORIES



Welding Machines

Description	Code	Item Weight kg
LX Welding Machine Connexion Blue Light Manual 110v (32mm up to 160mm)	43 ECU 021	18.0
PLX Welding Machine Connexion Blue Light Manual 230v (32mm up to 160mm)	43 ECU 020	18.0
PLX Welding Machine Connexion Blue Light Barcode 110v (32mm up to 160mm)	43 ECU 023	18.0
PLX Welding Machine Connexion Blue Light Barcode 230v (32mm up to 160mm)	43 ECU 022	18.0
PLX Welding Machine Connexion Blue Manual 110v (32mm up to 450mm)	43 ECU 011	22.0
PLX Welding Machine Connexion Blue Manual 230v (32mm up to 450mm)	43 ECU 010	22.0
PLX Welding Machine Connexion Blue Barcode 110v (32mm up to 450mm)	43 ECU 013	22.0
PLX Welding Machine Connexion Blue Barcode 230v (32mm up to 450mm)	43 ECU 012	22.0

Includes: welding machine, flying leads adaptors (1 pair), hand scraper, USB data stick, 2 x cables with 90° angled connection and 4.7mm/4mm adaptors



Portable Welding Machines

Description	Code
PLX Welding Machine Nomad inc. Battery Charger (for repairs only)	43 ET1 ULN

Includes: welding machine, charger, 2 x battery, PLX adaptors



Welding Accessories

Description	Code
PLX Connexion Blue Storage Box	43 997 321
PLX Welding Machine Spring Adaptors (1 Pair)	43 EWO 004
PLX Weld Machine Fixed Output Lead 4m P3 40v x 4.7mm Mk4 RAP	43 EWO 007
PLX Terminal adaptor 4.7mm male x 4.0mm female (Pair)	43 EWO 002
PLX Close Contact Barcode Scanner	43 EWO 012
PLX Pipetools Hand Scraper	43 SPA 012
PLX Isopropanol Wipes	43 451 101

Full range of accessories available upon request

PREPARATION TOOLS



PLX+ Conductivity Tester Kit

Code	Durapipe Description/Comments
72TES001	Comprises of: verification unit, conductivity tester, cable set x 50m, extension cable roll x 50m



Peelers

Description	Code
PLX Pipetools SurPrep Multikit 32 - 110mm	43 MZO 018
PLX Pipetools Uniprep 1 Preparation Tool 90 - 400mm	43 MZO 020
PLX Pipetools Uniprep 4 Preparation Tool 63 - 225mm	43 MZO 019



Clamps

Description	Code
PLX 32 - 63mm Pipetools Universal Pipe Clamp	43 MZO 050
PLX 63 - 160mm Pipetools Universal Pipe Clamp	43 MZO 051
PLX 125 - 400mm Pipetools Universal Pipe Clamp	43 MZO 052
PLX 32 - 40mm to 63 - 75mm Pipetools Close-Fit Pipe Clamp	43 MZO 053





Cutters

<i>Description</i>	<i>Code</i>
PLX 32 - 63mm Pipetools Cutter	43 777 101
PLX 50 - 110mm Pipetools Cutter	43 728 100
PLX 110 - 160mm Pipetools Cutter	43 728 102
PLX 225mm Pipetools Virax Guillotine Pipe Cutter	43 728 200
PLX 315mm Pipetools Virax Guillotine Pipe Cutter	43 728 201



Protection Sleeves

<i>Description</i>	<i>Code</i>
PLX 32 - 40mm Pipetools Protection Sleeve	43 494 308
PLX 50 - 63mm Pipetools Protection Sleeve	43 494 310
PLX 63 - 75mm Pipetools Protection Sleeve	43 494 311
PLX 90 - 110mm Pipetools Protection Sleeve	43 494 313
PLX 110 - 125mm Pipetools Protection Sleeve	43 494 314

General Information

Health & Safety

Durapipe PLX products have been installed and used safely in large volumes over many years. However, good working practice is vital in ensuring safety; our products should be handled and processed in accordance with the British Plastics Federation guidelines. All pipe systems contain trace quantities of process residues and may also contain other materials such as pigments, antioxidants and UV stabilisers. Chemically unreactive, PE is regarded as being biologically inert.

Inhalation

PLX does not release harmful fumes at ambient temperature. The threshold limit value for PE dust is 10mg/m³ (8 hour time weighted average in the working environment), but the generation of such levels when working with PE pipe and/or fittings is extremely unlikely.

Physical contact

PE is not considered to be a skin irritant. Where PE dust is generated by cutting particles of PE, dust may cause eye irritation.

Fire Characteristics

When PE is heated in air, melting will occur at 120-135°C and decomposition will commence at approximately 300°C. Above this temperature PE will pyrolyse oxidatively to produce carbon dioxide, carbon monoxide, water and various hydrocarbons. These gases may ignite and provide heat that may accelerate the pyrolysis of more PE in the vicinity. In burning, molten droplets of material may be released which could ignite adjacent inflammable materials. Combustion of PE may release toxic materials - Avoid inhalation of smoke or fumes.

Electrofusion Jointing

During the electrofusion welding of PLX fittings molten PE is formed at the pipe/fitting joint interface.

If this molten material is allowed to contact the skin, it will adhere strongly and cause severe burns. Appropriate PPE must be used at all times.

Small quantities of fumes may be given off by molten PE – these are more pronounced at higher temperatures. In confined spaces ventilation must be provided to ensure safe working conditions.

Hot Works and Polyethylene Electrofusion

A Hot Work Permit is a permit that is needed in some countries and on some jobsites, in order to perform work that involves a source of ignition when flammable materials are in the vicinity, or that can be considered a fire hazard. Welding, soldering, cutting and brazing are all considered as hot works, as is grinding and drilling in the presence of flammable materials. These processes are usually carried out on metals.

The term welding is also used when joining polyethylene pipe and fittings through electrofusion, however there are no naked flames or sparks generated in the process. Heat is supplied through an electric current through embedded wires contained within the fittings. Please see pages 22-37 for the full procedures for making all types of electrofusion joints (Single Wall, Close-Fit, Pipe-in-Pipe or PLX Blue and pages 71-80 for PLX+).

The maximum heat that is reached is 230°C and this causes the PE material to melt. This molten material is contained within the cold zones of the fittings, with no exposure to air. The local external temperature on the pipe and fitting does not exceed 80°C. Providing the correct procedures are followed and the work is carried out by a competent person, then there is no fire hazard. There is no need to apply a Hot Works Permit to electrofusion polyethylene welding procedures.

PLX Temperature Parameters

PLX pipework system complies with BS EN 14125:2013, which states in clause 5.3 (Temperature):

Temperature Class T2: Underground pipework shall be fully operational between -20°C and +50°C, but suitable for transport and storage at -40°C and +50°C.

Durapipe UK recommends that the PLX pipework system can be installed in temperatures down to -5°C.

Care must be taken when handling and preparing the product. When jointing at temperatures below -5°C, a space heater should be provided for the welding shelter, to raise the ambient temperature above -5°C. All products must also have been acclimatised to above -5°C prior to welding.

Handling and Storage

PLX pipe and fittings are resilient, lightweight and easy to handle. Nonetheless, care must be taken not to cause excessive scuffing or gouging of the surface of the pipe. In addition to the guidelines set out below, the handling and storage of PLX pipes is covered by the codes of practice issues in the IP specification for Underground Pipework Systems.

Handling

PLX Straight Length Pipes

A flat bed vehicle, free from sharp objects and projections should be used for the transportation of PLX pipe systems. When lifting pipe bundles by crane, wide polypropylene slings must be used. Do not use chains, hooks or hawsers. When lifting pipe bundles containing pipe lengths greater than six metres a load, a spreading beam should be used.

Allow for a certain degree of deflection or slight bending of the pipe bundles when loading or unloading. Standard six metre bundles may be handled using a forklift, but longer lengths should be moved using a side loader fitted with a minimum of four supporting forks, or using a crane fitted with a spreader beam.

PLX Coils

PLX coils of small diameter pipes can be easily manhandled. Where forklifts are used to off load coils of larger diameter pipe, the forks should be protected to avoid damaging the outer surfaces of PLX pipe.

Standing PLX coils upright will create excessive point loads that, on loose ground can cause serious or irreparable damage to PLX primary or secondary pipe.

PLX coils must not be dropped from any height.

Releasing Coils

Pipe held in coils is under tension and during manufacture is strapped accordingly. Dependent on the pipe size and coil length, coiled pipes are secured in layers or parts of and must be released in the correct order. Generally, coils should be released only as the pipe is withdrawn for use. In all cases the pipe end must be restrained at all times.

Storage

Badly stacked coils or bundles of pipe may slip or collapse causing injury to personnel as well as damage to the product.

PLX Straight Length Pipes

PLX pipe lengths stored individually should be stacked in a pyramid not more than one metre high with the bottom layer fully restrained by wedges/side supports. To avoid load damage and distortion pipes should be stored in their original packaging, off the ground and the bottom layer of pipes laid on levelled timber battens spaced at one metre centres.

Pipes of only one size should be stored in each pyramid and individual lengths should not be allowed to cross one another.

Pipe Crates and Pipe Bundled Packs

Bundled packs or crates should be stored on clear, level ground with battens supported by timbers. Bundled packs and crates should never be stacked more than three high or maximum of three metres.

PLX Coils

PLX pipe coils should be stored flat on firm level ground and supported on timber battens to protect the bottom of the coil. Point loads caused by the pipes being stored upright or rolled should be avoided.

Facilities for safe lifting, movement and loading/unloading must be available. Pipe coils should not be rolled.

PLX Pipe Fittings

PLX Electrofusion and spigot fittings are individually packed in heat sealed 400g polythene bags. Factory packed for maximum protection against contamination, the fittings should be stored in their original packaging in dry secure conditions and selected for use in stock rotational order.

The fittings individual packaging should be retained until immediately prior to installation and any unused fittings should be re-bagged immediately. Prior to these fittings being used in the future, electrofusion sockets and prepared spigot fittings should be cleaned using Durapipe Isopropanol wipes.

Durapipe PLX Piping System – Warranty

Save for its statutory liabilities the following constitutes the sole and exclusive obligations of Glynwed Pipe Systems Ltd trading as Durapipe UK to the Distributor or any person acquiring title through the Distributor, is in lieu of all other warranties, expressed and implied, and there are no implied warranties of merchantability or fitness for particular purpose, except as follows:

Each such warranty, as described above, is subject to the following conditions and limitations:

1. The PLX Underground Piping System must be installed in accordance with Durapipe UK published installation instructions and in accordance with prevailing government regulations and codes and must be used in accordance with Durapipe UK specifications.
2. The PLX underground piping system is used for liquid fuels. For other liquid fuels, please contact our technical support department.
3. The PLX underground piping system must be comprised solely of Durapipe UK pipes, fittings and accessories and must be jointed using the specified PLX equipment.
4. All of the warranties described above shall apply to the original installation only.
5. Durapipe UK shall not be liable for damage to or defects in any products caused by improper transportation, storage or other misuse, neglect or accident, nor does this warranty apply to any products which have been repaired or altered in any way which in the sole judgement of Durapipe UK, affects the performance, stability or general purpose for which they are manufactured.

In addition to our standard conditions of sale on page 94 of the Durapipe Technical Brochure 2017, Durapipe offer the following:

In normal operating conditions and where the product has been installed and operated in line with the instructions on page **, PLX has a design life of 30 years. The PLX system uses polyethylene material from the PE100+ Association, as used within the UK gas industry as the benchmark, which is then de-rated for liquid fuels at a ratio of 1.5:1.

If a Durapipe product fails in service, then the cause of failure will be investigated.

The process is as follows:

1. Customer lodges complaint with Durapipe Technical Department technical@durapipe.co.uk
2. NCR is registered at Durapipe.
3. Customer sends product sample to Durapipe for investigation.
4. Durapipe conduct a thorough report, ascertaining the cause of the product failure.
5. Durapipe aim to complete report and return to customer within 4-6 weeks of receipt of samples.

If this failure is deemed to be down to a manufacturing defect or fault and not due to misuse or installer error, then Durapipe UK will compensate accordingly.

Liability under this warranty shall be limited to:

1. Liability for death or personal injury resulting from its negligence.
2. At its option either:
 - a. The repair of the defective Durapipe UK components of the PLX Underground Piping System;
 - b. The replacement of the defective Durapipe UK components of the PLX Underground Piping System; or
 - c. Refund of the purchase price of the PLX underground piping system as charged to the Distributor.

Note: Durapipe UK shall not be liable for labour or other installation or replacement costs incurred in connection with the replacement products furnished in accordance with the terms of this warranty, nor shall Durapipe UK be liable for the costs of removal or re-installation of any product.

3. Liability for direct damage to material property as a result of a sudden and accidental discharge or dispersal of fuel directly caused by a defect in the Product. Under no circumstances shall Durapipe UK liability under this clause exceed £5 million for an event or a series of events.

DURAPIPE UK CONDITIONS OF SALE

1. **DEFINITIONS:**
 'Seller' shall mean Glynwed Pipe Systems Limited, registered in England under number 1698059. 'Buyer' shall mean any company, organisation or individual to whom a quotation is offered, or whose order is accepted by the Seller.
2. **CONDITIONS:**
 All offers, quotations, estimates, acceptances and contracts are subject to these Conditions of Business and any terms or conditions which any other person shall seek to impose or make part of any contract shall, so far as is inconsistent with these Conditions of Business, not apply unless expressly agreed by the Seller in writing. The headings in these conditions are for convenience only and shall not affect their interpretation.
3. **QUOTATIONS, PRICE VARIATIONS AND MADE TO ORDER GOODS:**
 - a) Any quotation given by the Seller is an invitation to the Buyer to make an offer only and no order of the Buyer placed with the Seller in pursuance of a quotation or otherwise shall be binding on the Seller unless and until it is accepted in writing by the Seller.
 - b) Unless stated otherwise, all quotations and published price lists are ex works, exclusive of VAT and shall remain valid for 30 days or such period as may be quoted but nevertheless the Seller may amend or withdraw any quotation by written or oral notice. Quotations may be varied if the Buyer makes variations in his specifications but see special conditions relating to Made to Order Goods.
 - c) Certain products are denoted 'MTO' in the Seller's published price lists. These products are Made to Order Goods and the Seller manufactures or procures these goods on a bespoke basis only. Where a Buyer has made an offer for "MTO" products that the Seller has accepted in writing the Buyer forfeits their right to cancel their offer unless the Seller confirms in writing that it will accept cancellation by the Buyer. Where the Seller does not provide written confirmation of the Buyer's cancellation the Buyer remains liable for the full contractual value of all 'MTO' products. 'MTO' 'Call-off' orders must be taken within 12 months of the original order date.
4. **STATEMENTS OR REPRESENTATIONS TO THE BUYER:**
 If any statement or representation has been made to the Buyer upon which the Buyer relies other than in the documents enclosed with the Seller's quotation, the Buyer must set out that statement or representation in a document to be attached to or endorsed on the order in which case the Seller may submit a new quotation.
5. **DELIVERY - TIME:**
 - a) Any period for delivery given at any time and in any manner by the Seller is an estimate only and is not binding on the Seller. Delivery periods are normally calculated from the later of:
 - i) acceptance of order; or
 - ii) where applicable, the receipt by the Seller of a detailed specification or drawings.
 - b) Time shall not be deemed to be of the essence of the contract. Failure by the Seller to meet any quoted delivery period for any part or the whole of the order shall not entitle the Buyer to rescind the contract or to claim damages of any nature.
 - c) The Seller will endeavour to comply with reasonable requests by the Buyer for postponement of delivery but shall be under no obligation to do so. Where delivery is postponed otherwise than due to default by the Seller the Buyer shall pay all costs and expenses including a reasonable charge for storage and transportation occasioned thereby and an extra charge for split delivery if applicable.
 - d) The Buyer will receive delivery of any consignment between the hours of 8.00am and 4.00pm Monday to Friday inclusive, unless otherwise agreed in writing. Cost incurred by the Seller arising from the Buyer's refusal to accept consignments within the agreed hours shall be borne by the Buyer.
6. **DELIVERY AND RISK:**
 - a) Except where stated to the contrary in the contract, delivery shall be made as follows:
 - i) where the Buyer provides the transport, delivery shall be made ex the Seller's works;
 - ii) where the Seller provides the transport, delivery shall be made to the premises of the Buyer, or the premises of the Buyer's customer or works site if the Buyer has requested delivery to be so made but where the Buyer has made such a request the Seller will make a first delivery to the Buyer's customer or works site as so much of the goods as is available for that delivery but subsequent deliveries will be made to the premises of the Buyer.
 - b) The Seller may at its discretion make partial delivery of orders and invoice the same.
 - c) Risk in the goods shall pass on delivery.
 - d) Where goods are sent FOB the Seller's responsibility shall cease when the goods are placed on board ship or aircraft without the need for the Seller to give notice to the Buyer and the provisions of Section 32(3) of the Sale of Goods Act 1979 shall not apply.
7. **OWNERSHIP OF GOODS:**
 - a) The goods shall remain the sole and absolute property of the Seller as legal and equitable owner until such time as the Buyer shall have paid to the Seller the contract price together with the full price of any other goods the subject of any contract between the Seller and the Buyer.
 - b) The Buyer acknowledges that until such time as the property in the goods passes to the Buyer he is in possession of the goods as a bailee and fiduciary agent for the Seller and the Purchaser shall store the goods in such a manner that they are clearly identifiable as the property of the Seller.
 - c) Until payment due under all contracts between the Buyer and the Seller had been made in full, in the event of sale of the goods by the Buyer:
 - i) the Seller shall be entitled to trace all proceeds of sale received by the Buyer through any bank or other account maintained by the Buyer; and
 - ii) the Buyer shall if requested by the Seller in writing to so assign its rights to recover the selling price of the goods from the third parties concerned. Such monies to be held separately by the Buyer as agent on behalf of the Seller.
 - d) The Seller may for the purpose of recovery of its goods enter upon any premises where they are stored or where they are reasonably thought to be stored and may repossess the same.
8. **TERMS OF PAYMENT:**
 In the event of default in payment according to the agreed payment terms between the Seller and the Buyer – i.e. by the end of the month following the month of despatch of the goods the Seller shall be entitled without prejudice to any other right or remedy to suspend all further deliveries and to charge interest on any amount outstanding at the rate of 2% per month until payment in full is made (a part of a month being treated as a full month for the purpose of calculating interest).
9. **SHORTAGES AND DEFECTS APPARENT ON DELIVERY:**
 - a) It shall be the responsibility of the Buyer to inspect or arrange for an inspection of the goods on delivery whether the goods are delivered to the Buyer's premises or to the premises of the Buyer's customer or to a works site. If no such inspection is made the Buyer shall be deemed to have accepted the goods.
 - b) The Buyer shall have no claim for shortages or defects apparent on inspection unless:
 - i) a written complaint is made to the Seller within three days of receipt of the goods specifying the shortage or defect; and
 - ii) the Seller is within seven days of receipt of the complaint given an opportunity to inspect the goods and investigate the complaint before any use is made of the goods.
 - c) If a complaint is not made to the Seller as herein provided then in respect of such shortages or defects the goods shall be deemed to be in all respects in accordance with the contract and the Buyer shall be bound to pay for the same accordingly.
10. **CLAIMS FOR DEFECTS NOT APPARENT ON INSPECTION:**
 - a) The Buyer shall have no claim for defects not apparent on inspection unless the Seller is notified of defective workmanship or materials within twelve months from delivery of the goods. Provided that the goods have been installed and applied in accordance with any relevant recommendations made by the Seller, the Seller will at its option replace the goods or refund the net invoiced price in respect of the goods which have been shown to be defective. If the Seller does so supply substitute goods the Buyer shall be bound to accept such substituted goods in full satisfaction of the obligations of the Seller under the contract.
 - b) The Buyer shall in any event have no claim or set-off in respect of defects unless a written complaint is sent to the Seller as soon as the defect is noticed and no use is made of the goods thereafter or alteration made thereto by the Buyer before the Seller is given an opportunity to inspect the goods.
 - c) The Buyer is responsible for ensuring that the goods are fit for any particular purpose, and no warranty or condition of fitness for any particular purpose is to be implied into the contract.
11. **LIABILITY:**
 Save as stated in Conditions 9 and 10 (and save in respect of death or personal injury resulting from the negligence of the Seller its servants or agents) the Seller shall not be liable for any claim or claims for direct or indirect consequential or incidental injury loss or damage made by the Buyer against the Seller whether in contract or in tort (including negligence on the part of the Seller its servants or agents) arising out of or in connection with any defect in the goods or their fitness or otherwise for any particular purpose or any act omission neglect or default of the Seller its servants or agents in the performance of the contract.
12. **FORCE MAJEURE:**
 Notwithstanding anything herein contained neither the Buyer nor the Seller is to be held liable for any delay or failure to carry out the contract due wholly or in part to an act of God action by any Government whether British or foreign civil war strikes and/or lockouts whatsoever occurring fire trade disputes floods or unfavourable weather or any material becoming unavailable or irreplaceable (whether at all or at commercially acceptable prices) or any other circumstances beyond the control of the Seller.
13. **SUB-CONTRACTING:**
 The Seller reserves the right to sub-contract the fulfilment of any order or any part thereof.
14. **INSOLVENCY AND BREACH OF CONTRACT:**
 In the event that:
 - a) the Buyer commits any breach of the contract and fails to remedy such breach (if capable of remedy) within a period of thirty days from receipt of a notice in writing from the Seller requesting such remedy; or
 - b) any distress or execution is levied upon any of the goods or property of the Buyer; or
 - c) the Buyer offers to make any arrangements with or for the benefit of its creditors or (if an individual) becomes subject to a petition for a bankruptcy order or (being a limited company) has a receiver appointed of the whole or any part of its undertaking property or assets; or
 - d) an order is made or a resolution is passed or analogous proceedings are taken for the winding up of the Buyer (save for the purpose of reconstruction or amalgamation with insolvency and previously approved in writing by the Seller) the Seller shall thereupon be entitled without prejudice to its other rights hereunder forthwith to suspend all further deliveries until the default has been made good or to determine the contract and any unfulfilled part thereof or at the Seller's option to make partial deliveries. Notwithstanding any such termination the Buyer shall pay to the Seller at the contract rate for all the goods delivered up to and including the date of termination.
15. **INDUSTRIAL PROPERTY RIGHTS:**
 If goods supplied by the Seller to the Buyer's design or specifications infringe or are alleged to infringe any patent or registered design right or copyright the Buyer will indemnify the Seller against all damages, costs and expenses incurred by the Seller as a result of the infringement or allegation. The Buyer will give the Seller all possible help in meeting any infringement claim brought against the Seller.
16. **BUYER'S ERROR IN ORDERING:**
 In the event the Buyer orders incorrectly the Seller will be under no obligation to the Buyer to rectify or assist in rectifying the error.
17. **LAW AND JURISDICTION:**
 The contract shall be subject in all respects to English Law and to the jurisdiction of the English Courts.

Durapipe UK reserves the right to modify the details in this publication as products and specifications are updated and improved. The content of this publication is for general information only and it is the user's responsibility to determine the suitability of any product for the purpose intended.

For further information on all Durapipe UK products and services contact our Customer Services Department as detailed below.

Customer Services

Tel: +44 (0)844 800 5509

Fax: +44 (0)1543 471682

Durapipe UK is a trade name of Glynwed Pipe Systems Ltd. Company Number 1698059.

Durapipe UK

Swaffield Park

Hyssop Close

Hawks Green

Cannock

Staffs

WS11 7FU

United Kingdom

Tel: +44 (0)1543 471680

Fax: +44 (0)1543 471690

email: enquiries@durapipe.co.uk

web: www.durapipe.co.uk

Twitter: @DurapipeUK



Certificate no. FM34819

Distributor